













Almacén de Fontanería

FONTANERÍA











P.V.C. - EVACUACIÓN

Ø	REF.		REF.	REF.	
45° □ €			45° □ €		
	32 H-H 0232903245			32 H-H 0232133245	50 0,85
	32 M-H 0232920324	120 0,55		40 H-H 0232134045	55 0,96
	40 H-H 0232904045			50 H-H 0232135045	40 3,54
	40 M-H 0232920404	80 0,65		75 M-H 0232130754	40 4,10
	50 H-H 0232905045			90 M-H 0232130904	25 4,20
	50 M-H 0232920504	85 1,67		110 M-H 0232131104	20 4,29
	75 M-H 0232920754	50 2,25		125 M-H 0232131254	16 7,69
	90 M-H 0232920904	90 1,95		160 M-H 0232131604	6 16,31
	110 M-H 0232921104	60 2,16		200 M-H 0232132004	3 42,54
	125 M-H 0232921254	44 3,19		250 M-H 0232132504	1 80,89
	160 M-H 0232921604	18 6,39		315 M-H 0232133154	1 214,03
	200 M-H 0232922004	8 16,93			
	250 M-H 0232922504	4 27,54			
	315 M-H 0232923154	1 109,11			
67° □ €			67° □ €		
	32 H-H 0232903267	90 0,64		32 H-H 0232133267	60 0,98
	32 M-H 0232920326	100 1,99		40 H-H 0232134067	60 1,90
	40 H-H 0232904067	120 0,65		50 H-H 0232135067	10 3,47
	40 M-H 0232920406	120 2,09		75 M-H 0232130756	50 6,56
	50 H-H 0232905067	70 2,03		90 M-H 0232130906	35 8,00
	50 M-H 0232920506	70 2,19		110 M-H 0232131106	20 8,82
	75 M-H 0232920756	40 2,39		125 M-H 0232131256	15 13,08
	90 M-H 0232920906	25 3,15		160 M-H 0232131606	7 35,50
	110 M-H 0232921106	35 3,47			
	125 M-H 0232921256	25 5,42			
	160 M-H 0232921606	12 16,75			
87° □ €			87° □ €		
	32 H-H 0232903287	100 0,37		32 H-H 0232133287	60 0,88
	32 M-H 0232920328	100 0,72		40 H-H 0232134087	70 0,96
	40 H-H 0232904087	110 0,38		50 H-H 0232135087	45 2,58
	40 M-H 0232920408	110 0,76		75 M-H 0232130758	50 3,35
	50 H-H 0232905087	65 0,96		90 M-H 0232130908	30 3,50
	50 M-H 0232920508	75 1,65		110 M-H 0232131108	25 3,61
	75 M-H 0232920758	40 1,82		125 M-H 0232131258	15 6,15
	90 M-H 0232920908	65 1,91		160 M-H 0232131608	8 11,06
	110 M-H 0232921108	45 1,96		200 M-H 0232132008	4 43,74
	125 M-H 0232921258	30 4,05		250 M-H 0232132508	2 116,36
	160 M-H 0232921608	15 7,97		315 M-H 0232133158	1 227,39
	200 M-H 0232922008	6 25,10			
	250 M-H 0232922508	3 46,35			
	315 M-H 0232923158	1 144,68			
	110 0232181104	12,81		110 0232221104	70,45
	125 0232181254	25,24		125 0232221254	86,35
	160 0232181604	73,10			
	110 0232181106	19,64		110 0232221106	78,59
	125 0232181256	24,38		125 0232221256	95,07
	110 0232181108	16,55		110 0232221108	74,33
	125 0232181258	25,41		125 0232221258	91,09
	160 0232181608	68,87			

D. D. ANGULAR

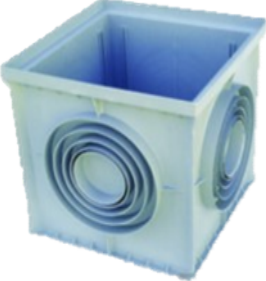
P.V.C. - EVACUACIÓN

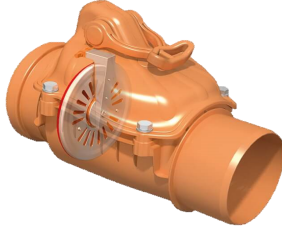
Ø	REF.	REF.	REF.
	* PUNTO DE REGISTRO	991301998	10,19
	110.125.40	0232111240	1,79
	110.125.50	0232111250	1,89
	75.50	0232000250	21,89
	90.50	0232000260	21,94
	110.90	0232000299	29,52
	125.110	0232000829	36,29
	160.50	0232000825	34,40
	160.110	0232000830	37,12
	160.125	0232000832	69,02
	200.110	0232000831	49,06
	200.125	0232000834	63,91
	200.160	0232000838	61,60
	15 26.30.32	0232263032	3,50
	15 30.34.32	0232303432	3,81
	25 34.38.40	0232343840	5,70
	110		
	460132036	64,52	
	125		
	460132037	84,59	
	*160		
	0232000060	95,87	
	20 x 20	991394102	5,92
	30 x 30	991394103	13,87
	40 x 40	991394104	32,43
	55 x 55	991394105	78,37
	20 x 20	991394106	12,52
	30 x 30	991394109	26,28
	40 x 40	991394107	46,00
	55 x 55	991394110	96,06
	20 x 20	991394115	6,06
	30 x 30	991394116	8,59
	40 x 40	991394117	11,40
	55 x 55	991394118	20,95
	50	1234	53,57
	75	1560	63,16
	110	991301235	82,59
	125	991301236	103,88
	160	991301237	114,45
	200	1238	239,86
	250	1239	570,29
	315	1280	799,64

P.V.C. - EVACUACIÓN

		Ø	□	REF.	€			Ø	□	REF.	€
		32	60	0232270032	0,49			40	60	0232300040	0,71
		40	90	0232270040	0,52			50	60	0232300050	0,84
		50	50	0232270050	0,93			75	25	0232300075	1,45
		75	35	0232270075	1,85			90	25	0232300090	2,50
		90	45	0232270090	1,88			110	35	0232300110	3,75
		110	55	0232270110	2,03			125	25	0232300125	5,12
		125	40	0232270125	4,29			160	15	0232300160	6,18
		160	22	0232270160	6,90			200	10	0232300200	10,95
		200	10	0232270200	18,03			250	5	0232300250	61,87
		250	2	0232270250	52,05						
		315	3	0232270315	79,83						
MANGUITO HH											
		40.32	45	0232004032	0,90			32	100	0232290032	1,10
		50.32	70	0232005032	0,95			40	120	0232290040	1,13
		50.40	60	0232005040	1,05			50	90	0232290050	3,15
		63.40		0232006340	1,32			75	30	0232290075	6,75
		75.50	50	0232007550	3,75			90	25	0232290090	7,12
		90.50	65	0232009050	3,95			110	15	0232290110	8,21
		90.75	50	0232009075	4,05			125	15	0232290125	9,75
		110.75	30	0232011075	4,25			160	15	0232290160	17,25
		110.90	25	0232011090	4,50			200	10	0232290200	19,32
		125.75	20	0232012575	4,50			250	5	0232290250	94,49
		125.90	20	0232012590	4,65			315	2	0232290315	165,69
		125.110	50	0232125110	5,15						
		160.110	45	0232160110	5,75						
		160.125	45	0232160125	6,75						
		200.160	9	0232200160	21,46						
	250.200	4	0232250200	43,71							
	315.250	4	0232315250	107,91							
REDUCC. EXT. EXC.											
		90		0232000303	8,76			75.40	25	0232075400	2,21
		110		0232000301	9,02			75.50	25	0232075500	2,47
		125		0232000300	7,34			90.40	25	0232090400	3,12
		160		0232000304	24,37			90.50	15	0232090500	3,12
MANGUITOM-H								110.32	20	0232110320	1,75
		110		0232000102	12,41			110.40	15	0232110400	1,94
		125		0232000101	12,90			110.50	15	0232110500	2,24
	BAJANTE URALITA							110.90	15	0232110900	2,82
		90.75		0232000975	11,32			125.40	25	0232125400	4,84
		110.90		0232001190	12,55			125.50	25	0232125500	5,18
		125.110		0232001211	14,29			125.110	25	0232125011	3,61
		200.160		0232002016	34,00			160.110	15	0232160011	6,32
		250.200		0232002520	87,26			160.125	15	0232160012	7,04
CONO								200.110	10	0232200011	16,44
		110.40.32	35	0232114032	3,35			200.125	10	0232200012	15,21
		110.40.40	40	0232114040	3,43		200.160	10	0232200016	15,33	
		125.40.40	25	0232124040	4,74						
		125.50.50	25	0232125050	5,32						
REDUCC. DOBLE											
		110.40.40.40		0232110444	4,09						
		125.40.40.40		0232125444	4,59						
	REDUCC. TRIPLE										
		75		0232000075	12,48						
		90		0232000090	9,11						
		110		0232000110	8,30						
		125		0232000125	8,86						
		160		0232000160	30,19						
MANGUITO REPARACIÓN											

C-80
BOOK









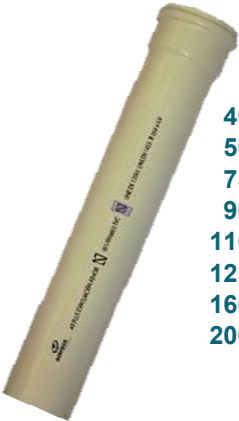

Solución C-80

Portarrollo
con llave de escuadra



Montaje **vertical** u **horizontal**

P.V.C. - EVACUACIÓN INSONORIZADO

MEDIDA	REF.	□	€	MEDIDA	□	REF.	€
	40x5	624540500					35,66
	50x5	624550500					40,51
	75x3	624575300					37,80
	90x3	624590300					50,86
	110x3	624511030					56,50
	125x3	624512530					79,69
	160x3	624516030					105,34
200x3	624520030					172,21	
	90x67	0245929067	25				10,15
	110x67	0245921106	35				10,91
	125x67	0245921256	25				15,32
	M-H 40x45	0245924045	30				2,05
	40x45	0245904045	30				2,46
	50x45	0245905045	20				3,40
	75x87	0245927587	10				6,69
	90x87	0245929087	20				8,84
	110x87	0245921108	30				9,01
	125x87	0245921258	20				16,43
	160x87	0245921608	8				32,56
	200x87	0245922008	6				59,43
	250x87	0245922508	3				96,80
	40x67	0245904067	30				3,75
	40x87	0245924087	30				2,56
	40x87	0245904087	30				2,55
	50x87	0245905087	15				3,83
	75x87	0245272075	20				5,54
	90	0245272090	40				8,86
	110	0245272110	55				10,02
	125	0245272125	35				13,23
	160	0245272160	8				24,46
	200	0245272200	4				41,21
	75x45	0245927545	15				5,85
	90x45	0245929045	30				7,37
	110x45	0245921104	40				7,70
	125x45	0245921254	25				12,35
	160x45	0245921604	15				23,45
	200x45	0245920004	8				47,65
	90x110	0245090110	25				11,64
90x125	0245090125	20				13,99	
110x125	0245110125	10				14,23	
110x160	0245110160	15				22,88	
125x160	0245125160	15				25,12	
200x125	0245200125	5				30,82	
200x160	0245200160	6				38,47	

P.V.C. - EVACUACIÓN INSONORIZADO

	MEDIDA	REF.	€		MEDIDA	REF.	€			
	40x45	0245134045	50	6,58		110/125x40				
						0245200174	35	8,21		
	50x45	0245135045	40	7,91		110/125x50				
						0245200175	35	8,22		
	40x87	0245134085	65	5,30		50	0245300500	30	3,15	
	50x87	0245135087	40	6,37		75	0245300750	15	4,32	
	75x45	0245200143	12	12,73		90	0245300900	30	6,78	
	90x45	0245200182	25	16,69		110	0245300110	35	8,05	
	110x45	0245131104	15	17,62		125	0245300125	25	11,12	
	125x45	0245131254	12	31,23		160	0245300160	15	14,32	
	160x45	0245200189	6	45,32		200	0245300200	10	24,35	
	200x45	0245200191	3	99,34						
	75x87	0245200145	8	11,48		50x40	0245122116	30	4,05	
	90x87	0245200180	15	16,69		75x40	0245007540	15	2,75	
	110x87	0245131108	20	17,62		90x40	0245009040	30	4,15	
	125x87	0245200161	15	25,43		75x50	0245007550	15	2,90	
	160x87	0245200188	8	54,36		90x50	0245009050	30	4,25	
	200x87	0245200190	4	99,43		110x40	0245110400	35	5,15	
	110x45	0245181104	12	51,11		110x50	0245110500	35	5,25	
	125x45	0245181254	10	72,34		110x75	0245110750	15	5,35	
		110x87	0245200192	15		51,11	125x50	0245125500	25	6,05
		125x87	0245200186	10		72,34				
	110x40x40	0245110404	40	10,54			110x40x40			
	110x40x40x40	0245114040	55	10,01						
	110x87	0245200192	15	51,11		LUBRICANTE				
	125x87	0245200186	10	72,34		040260750		7,53		

P.V.C. - PRESIÓN

Ø		REF.		€		Ø		REF.		€	
	CODO HH		45°	€	90°	€					
	16	023645016	0,87	023690016	0,55						
	20	023645020	0,88	023690020	0,59						
	25	023645025	0,90	023690025	0,84						
		M-H		32	023645032	1,41	023690032	1,17			
		40	023645040	1,73	023690040	1,61					
		50 M-H				023690540	4,00				
		63	023645063	3,68	023690063	3,91					
		75	023245075	6,22	023690075	6,15					
		90	023645090	9,59	023690090	10,17					
		CRUZ		16	023613016	1,63					
		20	023613020	0,74							
		25	023613025	0,88							
	32	023613032	1,44								
	40	023613040	2,13								
	50	023613050	3,45								
	50 CRUZ		63	023618050	9,57						
	63	023613063	4,20								
	75	023613075	8,42								
	90	023613090	15,39								
	TE IGUAL H		25	023630025	0,56						
	32	023630032	0,78								
	40	023630040	1,46								
	50	023630050	1,83								
	63	023630063	2,43								
		TAPÓN H		25	023602016	0,50					
32		023602520	0,51								
40		023603225	0,56								
50		023604020	0,91								
63		023604025	0,92								
	CASQUILLO REDUCTOR		40.20	023604032	0,82						
	40.25	023604032	0,82								
	40.32	023604032	0,82								
	50.40	023605040	1,04								
	63.50	023606350	1,44								
	75.63	023607563	2,34								
	90.75	023609075	4,02								
		VÁLVULA ESFERA		20 ENCOLAR	461200020	10,21					
		25 ENCOLAR	461200025	12,23							
		32 ENCOLAR	461200032	18,36							
40 ENCOLAR		461200040	20,44								
50 ENCOLAR		461200050	25,43								
63 ENCOLAR		461200063	37,19								
75 ENCOLAR		461200075	200,97								
90 ENCOLAR		461200090	221,18								
1/2" ROSCA/H		461200012	10,21								
3/4" ROSCA/H		461200034	12,23								
	ENLACE DE REPARACIÓN		1" ROSCA/H	461200001	18,36						
	1 1/4" ROSCA/H	461200114	22,25								
	1 1/2" ROSCA/H	461200112	31,66								
	2" ROSCA/H	461200002	43,17								
	50 ENCOLAR	023736505	26,08								
	63 ENCOLAR	023736506	34,08								
	COLLARÍN PLÁSTICO		20.1/2	023698000	2,09						
	25.1/2	023698001	1,94								
	25.3/4	023698002	2,09								
	32.1/2	023698003	2,92								
	32.3/4	023698004	2,76								
	32.1"	023698005	2,84								
	40.1"	023698008	3,10								
	50.3/4	023698010	3,31								
	50.1"	023698011	3,31								
	63.1"	023698014	5,17								
	75.1"	023698019	7,81								
	90.1"	023698023	10,03								
	90.1"1/2	023698025	11,55								
	110.1"	023698028	11,55								
	110.1"1/4	023698029	11,55								
	110.1"1/2	023698030	11,55								
	ENCOLAR		25	460734025	2,41						
	32	460734032	3,43								
	40	460734040	4,13								
	50	460734050	5,05								
	63	460734063	7,37								
	ECO	ECO		50	023702331	5,48					
		63	023702332	8,06							
	ENCOLAR-RM	ENCOLAR-RM		50.1" 1/2	460734150	9,43					
		63.2	460734163	12,96							
		MANGUITO R/H		20.1/2	023627120	1,13					
25.3/4		023627125	1,45								
32.1"		023627132	1,44								
40.1 1/4		023627140	1,72								
50.1 1/2		023627150	2,54								
63.2		023627163	3,81								
	MANGUITO H/H		16	023627016	0,61						
	20	023627020	0,58								
	25	023627025	0,68								
	32	023627032	0,95								
	40	023627040	1,37								
	50	023627050	1,70								
	63	023627063	2,71								

P.V.C. - TUBERÍA GRIS

Ø	LARGO	REF.	€/tubo
---	-------	------	--------

SERIE B

32	5 mts.	621632500	19,44
40	5 mts.	621640500	22,96
50	5 mts.	621650500	28,95
75	5 mts.	621675500	43,97
90	5 mts.	621690500	52,82
110	5 mts.	621611050	68,32
125	5 mts.	621612550	78,15
160	5 mts.	621616050	104,32
200	5 mts.	621620050	156,73
250	5 mts.	621625050	212,00
315	5 mts.	621631504	149,30

110	1 mts.	621611010	28,37
125	1 mts.	621612510	35,08

75	3 mts.	621675300	26,45
90	3 mts.	621690300	31,76
110	3 mts.	621611030	41,05
125	3 mts.	621612530	46,96
160	3 mts.	621616030	62,74
200	3 mts.	621620030	94,28
250	3 mts.	621625030	121,87

ESTRUCTURADA

90	3 mts.	621590300	24,83
110	3 mts.	621511030	31,86
125	3 mts.	621512530	37,43
160	3 mts.	621516030	48,80

Hidrotubo Blanco	27 x 32	620800132	8,59
Hidrotubo Blanco	35 x 40	620800140	11,40
Hidrotubo Gris	13 x 16	620800016	7,48
Hidrotubo Gris	16 x 20	620800020	8,50
Hidrotubo Gris	20 x 25	620800025	8,88
Hidrotubo Gris	27 x 32	620800032	8,59
Hidrotubo Gris	35 x 40	620800040	11,40
Hidrotubo Gris	43 x 50	620800050	19,15
Hidrotubo Gris	55 x 63	620800063	27,18



COLLARIN INTUMESCENTE

Ø mm	REF.	€
110	300222110	46,87
125	300222125	68,54
160	300222160	96,32



Ø mm	REF.	€
110	991385110	30,95
125	991385125	32,59
160	991385160	42,70

GLOBO CORTA AGUAS BAJANTE



HIDROTUBO

* Rollo 50 mts.

P.V.C. - ADHESIVOS



ADHESIVO	Q	REF.	€	ADHESIVO	REF.	€	ADHESIVO	REF.	€
FYCE Bote 1Kg.	12	040401000	23,42	GRIFFON Extra Rapido 500 ml	040230207	16,46	COLLAK 1Kg.	040221100	19,40
FYCE Bote 500 grs.	24	040400500	13,55	GRIFFON PVC Bote C/Brocha 500ml	040232091	10,01	COLLAK 500grs.	040221500	11,15
FYCE Tubo 125 grs.	25	040400125	3,25	GRIFFON Extrarapido 250 ml	040237286	9,34	COLLAK 125grs.	040221125	3,17
Limpiador ½ litro	24	040420500	7,75				COLLAK 500grs. Flexible	040231500	12,12

P.V.C. - POLIETILENO CORRUGADO SN-8

Ø	REF.	€/mts
---	------	-------

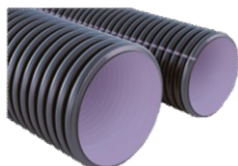

160	622210160	8,28
200	622210200	10,81
250	622210250	17,32
315	622210315	24,45
400	622210400	39,61

TUBERÍA LISA DE PRESIÓN

Ø mm.	LARGO	REF.	€/METRO
-------	-------	------	---------



16 x 20 atm.	5 mts.	621820016	1,29
20 x 20 atm.	5 mts.	621820020	1,29
25 x 16 atm.	5 mts.	621816025	1,59
32 x 16 atm.	5 mts.	621816032	2,55
40 x 10 atm.	5 mts.	621810040	2,51
50 x 10 atm.	5 mts.	621810050	3,47
63 x 10 atm.	6 mts.	621810063	5,36
75 x 10 atm.	6 mts.	621810075	7,66
90 x 10 atm.	6 mts.	621810090	10,95

**CANALETA NARVIK – 1 (Polipropileno)
CON REJILLA**

Altura 7 cm



- Dimensiones Externas: 1000 x 125 x 72 mm
- Dimensiones Internas: 1000 x 100 x 70 mm

MODELOS REJILLA – NARVIK 1

Referencia	Descripción	Resistencia	Ud / caja	€ / ud.
715000	Canaleta + Rejilla Acero Galvanizado	A-15	1	21,94
715001	Canaleta + Rejilla PE -HD Color Negro	A-15	1	15,99
715002	Canaleta + Rejilla PE -HD Color Gris	A-15	1	24,82
715112	Canaleta + Rejilla PE -HD Color Blanco	A-15	1	24,98
715003	Canaleta + Rejilla – Fundición Dúctil	A-15	1	45,06

**CANALETA NARVIK – 3 (Polipropileno)
CON REJILLA**

Altura 10 cm



- Dimensiones Externas: 1000 x 125 x 100 mm
- Dimensiones Internas: 1000 x 100 x 85 mm

MODELOS REJILLA – NARVIK 3

Referencia	Descripción	Resistencia	Ud / caja	€ / ud.
715020	Canaleta + Rejilla Acero Galvanizado	A-15	1	28,57
715021	Canaleta + Rejilla PE -HD Color Negro	A-15	1	20,80
715022	Canaleta – Fundición Dúctil	A-15	1	52,16
715023	Canaleta – Fundición Dúctil	C-250	1	79,53

P.V.C. - CANAL TRAPEZIAL BLANCA (DESARROLLO 260mm)

			Ø	REF.	€				REF.	€
			90	220190300	39,18	€/TRAMO			220126003	17,16
	long. 3 mts.									
			90	220127090	4,08				220126907	3,83
	BAJANTE MANGUITO									
			90 x 45	220104590	4,55				220126904	6,94
	CODO M-H									
			90 x 87	220108790	4,93				220126664	3,87
	CODO M-H									
			90	220110090	1,58				220126916	1,45
	COLLARIN									
				220126978	1,31				220126903	1,81
	GANCHO									
	TRAMO									
	long. 3 mts.									
	ANGULO UNIVERSAL									
	BAJANTE CENTRAL									
	MANGUITO TRANSICION									
	TAPA									
	UNION PERFIL									

P.V.C. - CANAL CIRCULAR GRIS

			Ø	REF.	€				Ø	REF.	€
			25	220625114	20,24	€/TRAMO			25	220609025	8,80
	long. 4 mts.		33	220633164	39,72				33	220629033	13,11
			25	220610025	5,90						
	UNIÓN CANALON		33	220632033	8,40						
			25	220609225	4,51				25	220609925	1,30
	BAJADA CENTRAL		33	220629233	12,86				33	220629933	2,80
			25	220609325	7,91						
	BAJADA EXT. IZQDA		33	220629333	11,95						
			25	220609425	8,03						
	BAJADA EXT. DRCHA		33	220629433	10,67						
			25	220609125	9,20						
	ANGULO INTERIOR		33	220629133	16,32						
	ANGULO EXTERIOR										
	TAPA UNIVERSAL										
	GARRA G.C.C.										
			90-75	220634383	4,10						
	REDUCC. CANAL		110-90	220634384	5,02						
	SOPORTES										
									(1)	220629533	1,85
									(2)	220629733	3,33
									(3)	220629633	3,88

COBRE

□ MEDIDA REF. €/mtr.

□ MEDIDA REF. €



CODO 90°
H-H 90 CU

10	10	021209010	2,16
25	12	021209012	0,74
10	15	021209015	0,74
10	18	021209018	1,10
10	22	021209022	1,82
10	28	021209028	3,03
	35	021209035	12,22
	42	021209042	20,02
	54	021209054	37,44



TE IGUAL
HEMBRA 130 CU

10	10	021201310	3,25
10	12	021201312	1,36
25	15	021201315	1,17
10	18	021201318	2,32
10	22	021201322	3,47
10	28	021201328	6,33
10	35	021201335	18,38
	42	021201342	34,51
	54	021201354	57,52



CODO 90°
M-H 92 CU

10	10	021209210	3,40
25	12	021209212	1,61
10	15	021209215	0,81
10	18	021209218	1,77
10	22	021209222	2,74
10	28	021209228	4,85
	35	021209235	19,23
	42	021209242	27,27
	54	021209254	52,09



PUENTE
H-H 85 CU

	12	021208512	3,96
	15	021208515	4,88
	18	021208518	13,16
	22	021208522	17,63



CURVA 45°
M-H 40 CU

10	12	021204012	1,89
25	15	021204015	0,85
10	18	021204018	2,02
10	22	021204022	1,96
10	28	021204028	4,16
10	35	021204035	15,69
	42	021204042	27,40
	54	021204054	45,07

10	12 x 10	021204031	2,55
10	15 x 12	021204063	1,40
25	18 x 12	021204093	3,34
10	18 x 15	021204096	1,17
10	22 x 12	021204043	6,40
10	22 x 15	021204046	3,18
10	22 x 18	021204049	2,18
	28 x 15	021204006	7,04
	28 x 18	021204009	6,86
	28 x 22	021204004	3,40
	35 x 18	021204089	17,41
	35 x 22	021204084	13,62
	35 x 28	021204080	16,73
	42 x 28	021204060	23,98
	42 x 35	021204068	18,77
	54 x 35	021204098	28,90
	54 x 42	021204097	24,87



REDUCCIÓN
H-H 240 CU

10	12	021204112	2,76
25	15	021204115	0,92
10	18	021204118	1,96
10	22	021204122	2,26
10	28	021204128	4,07
10	35	021204135	14,24
	42	021204142	25,06
	54	021204154	45,07



CURVA 45°
H-H 41 CU

COBRE

□ MEDIDA REF. €/mtr.

□ MEDIDA REF. €



TE REDUCIDA
130 CUR

15x12x12	021206633	5,32
15x12x15	021206636	2,62
15x15x12	021206637	4,19
15x18x15	021206696	6,56
15x22x15	021206646	8,41
18x12x12	021206933	9,06
18x12x15	021206936	7,37
18x15x15	021206966	3,18
18x15x18	021206969	1,93
18x18x15	021206996	3,89
18x22x18	021206949	8,99
22x15x15	021206466	5,76
22x15x18	021206469	6,38
22x15x22	021206464	2,74
22x18x15	021206496	7,86
22x18x18	021206499	6,83
22x18x22	021206494	4,19
22x22x15	021206446	8,73
22x22x18	021206449	10,35
28x15x15	021206043	15,05
28x15x28	021206060	6,39
28x18x28	021206090	11,25
28x22x22	021206044	13,21
28x22x28	021206045	7,13
28x28x15	021206006	25,63
28x28x18	021206009	22,14
28x28x22	021206004	17,46
35x22x35	021206848	20,50
42x22x42	021206501	31,78



MANGUITO UNIÓN
H-H 270 CU

10	10	021202710	0,60
10	12	021202712	0,51
25	15	021202715	0,46
10	18	021202718	0,71
10	22	021202722	1,16
10	28	021202728	2,11
10	35	021202735	5,22
	42	021202742	9,98
	54	021202754	16,62



TAPÓN HEMBRA
301 CU

10	12	021203012	2,35
25	15	021203015	1,22
10	18	021203018	1,50
10	22	021203022	2,56
	28	021203028	4,88

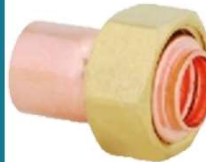

RACOR CON
REBORDE
359 GLCU

25	1/2"x12	021606032	1,73
25	1/2"x15	021606062	1,70
25	1/2"x18	021606092	2,45
25	1/2"x22	021606041	2,36
25	3/4"x15	021606063	2,94
25	3/4"x18	021606093	2,80
25	3/4"x22	021606043	3,12
25	3/4"x28	021606039	2,48
25	1"x22	021606044	4,51
25	1"x28	021606042	6,04
10	1 1/4"x28	021606045	8,67
10	1 1/4"x35	021606085	9,81
5	1 1/2"x42	021606104	6,64
4	2"x54	021606105	9,50

10	12 x 10	021204360	2,14
10	15 x 12	021204363	0,99
25	18 x 12	021204393	2,48
10	18 x 15	021204396	0,85
10	22 x 12	021204343	5,70
10	22 x 15	021204346	1,57
10	22 x 18	021204349	1,59
	28 x 12	021204303	9,99
	28 x 15	021204306	5,91
	28 x 18	021204309	6,51
	28 x 22	021204304	2,69
	35 x 18	021204364	10,38
	35 x 22	021204380	13,41
	35 x 28	021204383	8,88
	42 x 22	021204384	24,02
	42 x 28	021204389	26,07
	42 x 35	021204390	16,02
	54 x 35	021204397	36,86
	54 x 42	021204398	29,94



CURVO CON
REBORDE
2 AGLCU

25	1/2"x12	021200261	2,83
25	1/2"x15	021200262	2,73
25	1/2"x18	021200292	3,15
25	3/4"x18	021200293	4,48
25	3/4"x22	021200243	4,63
	1"x22	021200244	7,73



REDUCCION
M-H 243 CU



RACOR PLANO
359 P-GLCU



10	1/2"x12	100504529	1,84
10	1/2"x15	100504531	1,89
10	1/2"x18	100504533	2,69
10	1/2"x22	100504534	5,02
10	3/4"x15	100504536	3,18
10	3/4"x18	100504538	2,88
10	3/4"x22	100504539	3,40
10	1"x22	100504542	5,12

TUBERÍA DE COBRE

Ø	ACABADO	LARGO	REF.	€/mtr.	Ø	ACABADO	LARGO	REF.	€/mtr.																																																																						
 <p>TIRAS</p> <table border="1"> <tr><td>10 x 12</td><td>Pulido</td><td>5 mts.</td><td>640011200</td><td>3,77</td></tr> <tr><td>13 x 15</td><td>Pulido</td><td>5 mts.</td><td>640011500</td><td>4,65</td></tr> <tr><td>16 x 18</td><td>Pulido</td><td>5 mts.</td><td>640011800</td><td>5,70</td></tr> <tr><td>20 x 22</td><td>Pulido</td><td>5 mts.</td><td>640012200</td><td>7,01</td></tr> <tr><td>26 x 28</td><td>Pulido</td><td>5 mts.</td><td>640012800</td><td>8,97</td></tr> <tr><td>33 x 35</td><td>Pulido</td><td>5 mts.</td><td>640013500</td><td>10,93</td></tr> <tr><td>40 x 42</td><td>Pulido</td><td>5 mts.</td><td>640014200</td><td>13,50</td></tr> <tr><td>52 x 54</td><td>Pulido</td><td>5 mts.</td><td>640015400</td><td>20,95</td></tr> </table>					10 x 12	Pulido	5 mts.	640011200	3,77	13 x 15	Pulido	5 mts.	640011500	4,65	16 x 18	Pulido	5 mts.	640011800	5,70	20 x 22	Pulido	5 mts.	640012200	7,01	26 x 28	Pulido	5 mts.	640012800	8,97	33 x 35	Pulido	5 mts.	640013500	10,93	40 x 42	Pulido	5 mts.	640014200	13,50	52 x 54	Pulido	5 mts.	640015400	20,95	 <p>ROLLO</p> <table border="1"> <tr><td>8 x 10</td><td>Cromo</td><td>25 mts.</td><td>640000810</td><td>5,10</td></tr> <tr><td>10 x 12</td><td>Cromo</td><td>25 mts.</td><td>640001012</td><td>5,76</td></tr> <tr><td>8 x 10</td><td>Pulido</td><td>50 mts.</td><td>640000010</td><td>3,37</td></tr> <tr><td>10 x 12</td><td>Pulido</td><td>50 mts.</td><td>640000012</td><td>4,68</td></tr> <tr><td>13 x 15</td><td>Pulido</td><td>50 mts.</td><td>640000015</td><td>4,67</td></tr> <tr><td>16 x 18</td><td>Pulido</td><td>50 mts.</td><td>640000018</td><td>3,77</td></tr> </table>					8 x 10	Cromo	25 mts.	640000810	5,10	10 x 12	Cromo	25 mts.	640001012	5,76	8 x 10	Pulido	50 mts.	640000010	3,37	10 x 12	Pulido	50 mts.	640000012	4,68	13 x 15	Pulido	50 mts.	640000015	4,67	16 x 18	Pulido	50 mts.	640000018	3,77
10 x 12	Pulido	5 mts.	640011200	3,77																																																																											
13 x 15	Pulido	5 mts.	640011500	4,65																																																																											
16 x 18	Pulido	5 mts.	640011800	5,70																																																																											
20 x 22	Pulido	5 mts.	640012200	7,01																																																																											
26 x 28	Pulido	5 mts.	640012800	8,97																																																																											
33 x 35	Pulido	5 mts.	640013500	10,93																																																																											
40 x 42	Pulido	5 mts.	640014200	13,50																																																																											
52 x 54	Pulido	5 mts.	640015400	20,95																																																																											
8 x 10	Cromo	25 mts.	640000810	5,10																																																																											
10 x 12	Cromo	25 mts.	640001012	5,76																																																																											
8 x 10	Pulido	50 mts.	640000010	3,37																																																																											
10 x 12	Pulido	50 mts.	640000012	4,68																																																																											
13 x 15	Pulido	50 mts.	640000015	4,67																																																																											
16 x 18	Pulido	50 mts.	640000018	3,77																																																																											

* Los precios son orientativos. Confirmar precios en el momento de la compra

FONCAL









Ø	ACABADO	REF.	€/mtr.	Ø	ACABADO	REF.	€/mtr.																																
 <p>ROLLO 50 mts.</p> <table border="1"> <tr><td>16</td><td>AZUL</td><td>081000016</td><td>0,46</td></tr> <tr><td>19</td><td>AZUL</td><td>081000019</td><td>0,58</td></tr> <tr><td>23</td><td>AZUL</td><td>081000023</td><td>0,76</td></tr> <tr><td>29</td><td>AZUL</td><td>081000029</td><td>1,27</td></tr> </table>				16	AZUL	081000016	0,46	19	AZUL	081000019	0,58	23	AZUL	081000023	0,76	29	AZUL	081000029	1,27	 <p>ROLLO 50 mts.</p> <table border="1"> <tr><td>16</td><td>ROJO</td><td>081016000</td><td>0,46</td></tr> <tr><td>19</td><td>ROJO</td><td>081019000</td><td>0,58</td></tr> <tr><td>23</td><td>ROJO</td><td>081023000</td><td>0,76</td></tr> <tr><td>29</td><td>ROJO</td><td>081029000</td><td>1,27</td></tr> </table>				16	ROJO	081016000	0,46	19	ROJO	081019000	0,58	23	ROJO	081023000	0,76	29	ROJO	081029000	1,27
16	AZUL	081000016	0,46																																				
19	AZUL	081000019	0,58																																				
23	AZUL	081000023	0,76																																				
29	AZUL	081000029	1,27																																				
16	ROJO	081016000	0,46																																				
19	ROJO	081019000	0,58																																				
23	ROJO	081023000	0,76																																				
29	ROJO	081029000	1,27																																				

SOLDADURA

ESTANO	U/E	REF.	NETO	ACABADO	REF.	€		
	Cobre 3,5%	991332836	6,92	 <p>POLVO PLATEX</p>	125 grs.	991322722	11,06	
	Cobre 6%	991332837	6,92					
	CU 2 mm.	84	991332841	0,49	 <p>DECAPANTE</p>	80 grs.	991322720	6,00
	Ag 5% 2 mm.	82	991332842	1,33				

* Los precios son orientativos. Confirmar precios en el momento de la compra

ACCESORIOS COMPRESIÓN COBRE E INOXIDABLE

MEDIDA	REF.	€/NETO	MEDIDA	REF.	€/NETO		
 <p>CODO</p>	15	027866415	2,52	 <p>RACOR MACHO</p>	15x1/2	027863152	1,94
	18	027866418	3,74		18x1/2	027863182	2,48
	22	027866422	4,95		22x3/4	027863223	3,61
	15	027868015	4,03		 <p>RACOR HEMBRA</p>	15x1/2	027866152
18	027868018	5,75	18x1/2	027866182		2,68	
22	027868022	7,17	22x3/1	027866223		3,61	
 <p>TE</p>	15	027866015	2,52	 <p>CODO HEMBRA</p>	15x1/2	027865152	2,73
	18	027866018	3,44		18x1/2	027865182	3,83
	22	027866022	4,50		22x3/1	027865222	4,77
 <p>MANGUITO</p>	15	027866015	2,52	 <p>TE HEMBRA</p>	15x1/2	027860152	4,11
	18	027866018	3,44		18x1/2	027860182	5,75
	22	027866022	4,50		22x3/1	027860222	7,00
 <p>REDUCCIÓN</p>	18x15	027861815	3,65				
	22x18	027862218	5,04				



Almacén de Fontanería

Regístrate en nuestro ecommerce

Descúbrelo en
tienda.suministroscoplasa.es

Podrás consultar tus documentos
Ofertas - Pedidos - Albaranes - Facturas



También pedir
materiales 24h



Fácil, rápido y GRATIS

Captura con tu móvil este código QR
para acceder a un vídeo explicativo.

INOXIDABLE PRENSADO (Mordaza Perfil M) Fuerza 32kn

AISI 304	AISI 304	€/mtr.
15x0,6	628701506	1,22
18x0,7	628701807	1,65
22x0,7	628702207	1,98
28x0,8	628702808	3,50
35x1	628703510	5,05
42x1,2	628704212	6,09
54x1,2	628705412	7,94

BARRA 5 mts.



RACOR MACHO

MEDIDA	REF.	€
15x1/2	028724152	7,59
15x3/4	028724153	9,10
18x1/2	028724182	7,99
18x3/4	028724183	8,97
22x1/2	028724222	9,73
22x3/4	028724223	10,15
22x1/2	028724224	10,68
28x1	028724284	13,51
35x1"1/4	028724355	17,48
42x1"1/2	028724426	24,67
54x2	028724542	28,53

CURVA HH



15	028709015	5,34
18	028709018	5,99
22	028709022	7,25
28	028709028	9,03
35	028709035	13,92
42	028709042	21,98
54	028709054	29,80



RACOR HEMBRA

15x1/2	028727152	7,99
15x3/4	028727153	10,42
18x1/2	028727182	8,49
18x3/4	028727183	9,17
22x1/2	028727222	10,62
22x3/4	028727223	10,84
22x1	028727224	12,75
28x3/4	028727283	14,82
28x1	028727284	15,10
35x1"1/4	028727355	17,45
42x1"1/2	028727426	24,96
54x2	028727547	32,30



CURVA MH

15	028709215	5,02
18	028709218	5,70
22	028709222	7,21
28	028709228	8,88
35	028709235	13,92
42	028709242	21,67
54	028709254	28,82



REDUCCIÓN

18.15	028781815	3,99
22.15	028782215	4,42
22.18	028782218	4,47
28.15	028782815	7,19
28.18	028782818	5,96
28.22	028782822	7,19
35.15	028783515	15,67
35.18	028783518	12,00
35.22	028783522	7,95
35.28	028783528	8,15
42.15	028784215	15,56
42.18	028784218	15,49
42.22	028784222	12,74
42.28	028784228	13,32
42.35	028784235	9,78
54.42	028785442	12,24



MANGUITO HH

15	028727015	2,92
18	028727018	3,30
22	028727022	3,89
28	028727028	4,85
35	028727035	6,43
42	028727042	8,30
54	028727054	9,95



CODO 45° H-H

15	028704115	5,39
18	028704118	5,80
22	028704122	6,92
28	028704128	8,80
35	028704135	13,25
42	028704142	20,22
54	028704154	26,86



CODO PLACA

15.1/2	028747152	10,97
18.1/2	028747182	11,37
22.3/4	028747223	14,15



CODO 45° M-H











15	028704015	5,55
18	028704018	6,11
22	028704022	7,27
28	028704028	8,87
35	028704035	12,32
42	028704042	19,45
54	028704054	24,77

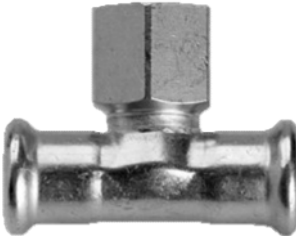

TE 90°

15	028713015	8,72
18	028713018	9,73
22	028713022	10,73
28	028713028	12,91
35	028713035	16,57
42	028713042	22,47
54	028713054	27,48

INOXIDABLE

MEDIDA			REF.	€	MEDIDA			REF.	€
 <p>RACOR MÓVIL</p>	15x1/2	028735152	10,94		3/4x1/2	026090011	2,65		
	15x3/4	028735153	11,17		1"x3/4	026090012	3,70		
	18x1/2	028735182	12,09		1"1/4x1"	026090013	5,00		
	18x3/4	028735183	12,35		1"1/2x1"1/4	026090014	6,10		
	22x3/4	028735223	14,48		2"x1"1/2	026090015	12,15		
	22x1	028735224	16,33		1/2"	026090041	3,20		
	28x1	028735284	17,98		3/4"	026090042	3,90		
	28x1"1/4	028735285	20,02		1"	026090043	5,60		
	35x1"1/4	028735355	20,41		1"1/4	026090044	8,40		
	42x1"1/2	028735426	27,55		1"1/2	026090045	9,20		
54x2	028735542	33,18	2"	026090046	13,15				
 <p>TE R/H</p>	15x1/2	028713152	9,46		1/2"	026090021	2,00		
	18x1/2	028713182	9,58		3/4"	026090022	3,15		
	18x3/4	028713183	10,44		1"	026090023	5,15		
	22x1/2	028713222	11,66		1"1/4	026090024	7,95		
	22x3/4	028713223	12,63		1"1/2	026090025	9,40		
	28x1/2	028713282	13,50	2"	026090026	14,75			
	28x3/4	028713283	14,49		1/2"	026090051	3,90		
	28x1	028713284	15,98		3/4"	026090052	5,65		
	35x1/2	028713352	14,97		1"	026090053	9,10		
	35x3/4	028713353	17,71		1"1/4	026090054	14,40		
35x1	028713354	18,71	1"1/2		026090055	18,30			
35x1"1/4	028713355	18,69	2"	026090056	29,20				
42x1"1/2	028713426	27,85	 <p>TE REDUCIDA</p>	18x15x18	028706969	8,77			
54x2	028713547	47,27		22x15x22	028706464	9,42			
 <p>TE REDUCIDA</p>	18x15x18	028706969		8,77		22x18x22	028706494	9,71	
	22x15x22	028706464		9,42		28x15x28	028706060	11,35	
	22x18x22	028706494		9,71		28x18x28	028706090	11,71	
	28x15x28	028706060		11,35		28x22x28	028706040	12,22	
	28x18x28	028706090		11,71		35x28x35	028706808	15,06	
	28x22x28	028706040		12,22	42x35x42	028706686	21,90		
	35x28x35	028706808		15,06	54x42x54	028706979	27,39		
	42x35x42	028706686		21,90	42x15x42	028706666	18,82		
	54x42x54	028706979	27,39	35x15x35	028706868	13,85			
	42x15x42	028706666	18,82	42x18x42	028706668	18,82			
42x18x42	028706668	18,82	42x22x42	028706678	20,34				
42x22x42	028706678	20,34	42x28x42	028706688	21,13				
42x28x42	028706688	21,13	 <p>CODO R/H</p>	15x1/2	028790152	10,20			
 <p>CODO R/H</p>	18x1/2	028790182		10,90	 <p>VALV. BOLA</p>	1/2"	026090031	14,76	
	18x3/4	028790183		12,90		3/4"	026090032	18,82	
	22x3/4	028790223		13,44		1"	026090033	23,17	
	28x1"	028790284		18,42		1"1/4	026090034	35,73	
	15x1/2	028790152		10,20		1"1/2	026090035	64,78	
	18x1/2	028790182	10,90	2"		026090036	94,27		

LATÓN

□	MEDIDA	REF.	€/mtr.	□	MEDIDA	REF.	€
---	--------	------	--------	---	--------	------	---



MACHÓN DOBLE

25	1/4	500656000	1,06
25	3/8	500656001	1,28
25	1/2	500656002	1,39
25	3/4	500656003	2,36
10	1"	500656004	4,12
10	1 1/4	500656005	7,08
10	1 1/2	500656006	9,26
	2"	500656007	14,86
	2 1/2	500656008	23,62
	3"	500656009	34,78



ALARGADERA REDUCIDA

25	M1/8xH1/4	500605022	1,29
25	M3/8xH1/2	500605026	1,39
25	M1/2xH3/4	500605028	2,00
10	M3/4xH1"	500605031	3,50
10	M1"xH1 1/4	500605036	5,51
10	M1"xH1 1/2	500605037	7,76
5	M1 1/4xH1 1/2	500605039	8,39
5	M1 1/2xH2"	500605041	11,68
10	H1xM1/2	500605029	3,15
	H2xM3/4	500605033	11,02
	H2xM1	500605038	11,92
	H2xM1 1/4	500605040	12,03



		NETO	
40	MACHÓN 1/2	500600001	30,00
40	ALARG. 1/2x1cm	500600002	33,00
25	ALARG. 1/2x2cm	500600003	27,00
20	MACHÓN 3/4	500600004	25,00
50	TAPÓN 1/2	500600005	30,00



MACHÓN RED

25	1/4 x 3/8	500657001	1,27
25	3/8 x 1/2	500657021	1,40
25	1/2 x 3/4	500657032	1,92
10	1/2 x 1"	500657042	3,38
10	3/4 x 1"	500657043	3,51
10	3/4 x 1 1/4	500657053	5,26
10	1" x 1 1/4	500657045	5,63
	1" x 1 1/2	500657046	7,15
	1" x 2"	500657047	11,97
10	1 1/4 x 1 1/2	500657056	8,21
	1 1/4 x 2"	500657057	11,87
	1 1/2 x 2"	500657067	12,39
	2" x 2 1/2	500657078	23,95
	2" x 3"	500657079	37,03
	2 1/2 x 3"	500657089	36,23



REDUCCIÓN EXAGONAL M-H

25	1/2x1/4	500680024	1,37
25	3/8x1/4	500680010	1,00
25	1/2x3/8	500680021	1,24
25	3/4x1/2	500680032	1,53
25	1"x1/2	500680042	3,04
25	1"x3/4	500680043	2,54
10	1 1/4x1/2	500680052	5,66
10	1 1/4x3/4	500680053	5,53
10	1 1/4x1"	500680054	4,61
10	1 1/2x1/2	500680062	6,84
10	1 1/2x3/4	500680063	6,57
10	1 1/2x1"	500680064	6,75
10	1 1/2x1 1/4	500680065	5,15
5	2"x1/2	500680072	12,05
5	2"x3/4	500680073	12,83
5	2"x1"	500680074	12,32
5	2"x1 1/4	500680075	12,71
5	2"x1 1/2	500680076	10,00
	2 1/2x2"	500680085	21,43
	3"x2"	500680095	40,98
	3x2 1/2	500680096	33,13



ALARGADERA M-H













25	3/8	500605015	1,16
25	1/2	500605016	1,52
25	1/2 x 2cm.	500605020	1,96
25	3/4	500605017	2,41
10	1"	500605018	3,74
10	1 1/4	500605019	6,04
Cromo			
	1/2 x 5 cm.	500605052	9,29
	1/2 x 10 cm.	500605053	13,36









RACOR DEPÓSITO

3/8	991368001	2,93
1/2	991368002	3,71
3/4	991368003	5,59
1"	991368004	7,26
1 1/4	991368005	11,89
1 1/2	991368006	17,59
2"	991368007	32,16
2 1/2	991368008	57,35
3"	991368009	86,92

LATÓN

□ MEDIDA REF. €/mtr.				□ MEDIDA REF. €					
 <p>CODO H-H</p>	25	3/8	500300901	2,20	 <p>TAPÓN MACHO</p>	25	3/8	500329001	0,97
	25	1/2	500300902	3,34		25	1/2	500329002	1,15
	10	3/4	500300903	5,02		25	3/4	500329003	1,80
	10	1"	500300904	9,16		25	1"	500329004	2,83
		1 1/4	500300905	15,01		10	1 1/4	500329005	4,09
		1 1/2	500300906	21,27		10	1 1/2	500329006	5,97
		2"	500300907	31,49		5	2"	500329007	8,57
		2 1/2	500300908	65,16					
 <p>CODO M-H</p>  <p>CODO TUERCA MÓVIL</p>	25	3/8	500300921	2,13	 <p>TAPÓN HEMBRA</p>	25	3/8	500303001	0,83
	25	1/2	500300922	3,41		25	1/2	500303002	1,12
	10	3/4	500300923	5,44		25	3/4	500303003	1,52
	10	1"	500300924	8,97		10	1"	500303004	2,50
		1 1/4	500300925	14,63		10	1 1/4	500303005	4,11
		1 1/2	500300926	22,23		10	1 1/2	500303006	5,09
		2"	500300927	30,18		10	2"	500303007	8,99
		2 1/2	500300928	72,29					
		1/2	500300932	3,69					
		3/4	500300933	5,57					
 <p>TE H-H-H</p>	25	3/8	500301301	2,76	 <p>RÁCOR CONTADOR</p>	3/4 x 1/2	991360102	4,31	
	10	1/2	500301302	4,05		1" x 3/4	991360103	6,71	
	10	3/4	500301303	5,72		7/8 x 1/2	991360178	4,98	
	5	1"	500301304	10,18					
		1 1/4	500301305	17,31					
		1 1/2	500301306	28,69					
		2"	500301307	43,21					
		2 1/2	500301308	91,46					
 <p>MANGUITO H-H</p> 	25	3/8	500302701	1,91	 <p>EMPLAZAMIENTO CONTADOR</p>	3/4 - 3/4	991360379	19,00	
	25	1/2	500302702	2,21		3/4 - 7/8	991360378	21,04	
	10	3/4	500302703	3,18					
	10	1"	500302704	4,70					
	5	1 1/4	500302705	8,31					
	5	1 1/2	500302706	11,56					
		2"	500302707	20,76					
		2" 1/2	500302708	41,87					
		1/2 x 3/4	500665203	2,67					
		1/2 x 1"	500665204	3,40					
 <p>UNIÓN 3 PIEZAS H-H</p>	1/2	500303402	7,75	 <p>COLLARÍN CON TOMA</p>	20 x 1/2	991314600	7,65		
	3/4	500303403	12,74		25 x 1/2	991314601	8,06		
	1"	500303404	16,09		32 x 1/2	991314602	10,32		
	1 1/4	500303405	25,89		40 x 1/2	991314603	16,25		
	1 1/2	500303406	32,78		40 x 3/4	991314607	15,45		
	2"	500334007	34,73		50 x 1/2	991314604	15,73		
	2 1/2	500334008	116,42		50 x 3/4	991314608	15,59		
						63 x 1/2	991314605	26,29	
				63 x 3/4	991314609	25,74			

LATÓN

□ MEDIDA REF. €/mtr.				□ MEDIDA REF. €					
	10	3/8 x 12	021609031	3,56		25	3/8 x 12	021604331	1,84
	25	3/8 x 15	021609061	2,79		25	3/8 x 15	021604361	1,76
	25	1/2 x 12	021609032	2,93		25	1/2 x 12	021604332	2,30
	25	1/2 x 15	021609062	3,34		25	1/2 x 15	021604362	2,23
	25	1/2 x 18	021609092	3,86		25	1/2 x 18	021604392	2,60
	10	1/2 x 22	021609042	5,70		25	1/2 x 22	021604342	3,21
	10	3/4 x 15	021609063	6,25		25	3/4 x 15	021604363	3,48
	10	3/4 x 18	021609093	5,73		25	3/4 x 18	021604393	3,32
	10	3/4 x 22	021609043	6,20		25	3/4 x 22	021604343	3,59
	10	3/4 x 28	021609045	10,46		10	3/4 x 28	021604303	6,15
	10	1" x 22	021609044	10,25		10	1" x 22	021604344	5,90
	10	1" x 28	021609004	12,15		10	1" x 28	021604304	5,22
		1 1/4 x 35	021609048	20,49		10	1 1/4 x 28	021604305	10,18
		1 1/2 x 42	021609049	38,75			1 1/4 x 35	021604306	10,73
	2" x 54	021609050	66,41		1 1/2 x 42	021604307	13,24		
						2" x 54	021604308	24,77	
	10	1/2 x 12	021609232	3,11		25	3/8 x 12	021607031	1,63
	25	1/2 x 15	021609243	4,08		25	3/8 x 15	021607061	1,76
	25	1/2 x 18	021609262	3,95		25	1/2 x 12	021607032	2,21
	10	3/4 x 18	021609263	4,80		25	1/2 x 15	021607062	2,43
	10	3/4 x 22	021609292	5,32		25	1/2 x 18	021607092	2,63
						25	1/2 x 22	021607042	3,12
				25		3/4 x 15	021607063	3,08	
				25		3/4 x 18	021607093	2,97	
				25		3/4 x 22	021607043	3,20	
				10		3/4 x 28	021607003	5,70	
				10		1" x 22	021607044	5,35	
				10		1" x 28	021607004	5,93	
						1 1/4 x 35	021607006	12,15	
				5		1 1/2 x 42	021607046	14,92	
					2" x 54	021607097	26,89		
	25	1/2 x 12	021603032	4,28		1/2 x 12	021607263	4,80	
	25	1/2 x 15	021603062	4,18		1/2 x 15	021607264	4,61	
	25	1/2 x 18	021603092	4,48		1/2 x 18	021607265	7,05	
	10	1/2 x 22	021603042	8,74					
	10	3/4 x 18	021603093	9,00					
	10	3/4 x 22	021603043	9,05					
	10	1" x 22	021603045	11,17					
		1" x 28	021603046	15,85					
	1 1/4 x 35	021603075	34,62						
	1 1/2 x 42	021603066	53,74						
	2" x 54	021603097	84,98						

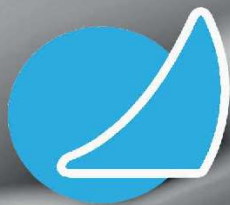

ISOLTUBEX®



Sistema MULTICAPA
Sistema I-PERT
Sistema SUELO RADIANTE



Accesorios de Compresión
Accesorios de Compresión
para tubería de Cobre/Inox
Accesorios de Casquillo Corredizo
Accesorios de Latón para Roscar











Tuberías y Accesorios de Polipropileno

Suelo radiante
Regulación y control











www.isoltubex.net





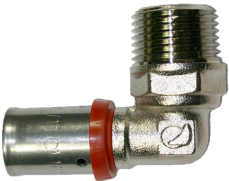







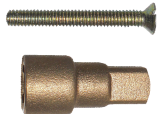

MULTICAPA ISOLTUBEX (Mordaza Perfil RF - Fuerza 32 kN)

□ MEDIDA				REF.	€/mtr.	□ MEDIDA				REF.	€						
 <p>ROLLO</p>					16x2 100MTS.	627011620	2,52	 <p>ROLLO AISLADO (50mts)</p>					16 x 2 AZUL	50mts	627051621	4,02	
					20x2 100MTS	627012020	3,42						20 x 2 AZUL	50mts	627052021	4,79	
					25x2,5 50MTS	627012525	4,87						25 x 2,5 AZUL	25mts	627052521	10,93	
					32x3 50 MTS.	627013230	7,50						16 x 2 ROJO	50mts	627051620	4,02	
					16x2 25MTS.	627031620	2,86						20 x 2 ROJO	50mts	627052020	4,79	
	20x2 25MTS.	627032020	3,60					25 x 2,5 ROJO	25mts	627052520	10,93						
 <p>BARRA (4 mts.)</p>					200	16 x 2	627021620	3,04	 <p>BARRA (4 mts.)</p>					80	25 x 2,5	627021525	7,39
					140	20 x 2	627022020	3,79									
					80	25 x 2,5	627022525	6,59									
					56	32 x 3	627023230	12,13									
					64	40 x 4	627024040	18,70									
					16	50 x 4,5	627025045	23,98									
					12	63 x 6	627026360	42,48									
 <p>CODO HEMBRA</p>					30	16 - 1/2	027090162	4,11	 <p>TE</p>					20	16-16-16	027013016	4,41
					22	20 - 1/2	027090202	4,70						14	20-20-20	027013020	6,32
					15	20 - 3/4	027090203	5,16						6	25-25-25	027013025	11,36
					12	25 - 1/2	027090252	6,04						4	32-32-32	027013032	15,81
					10	25 - 3/4	027090253	7,03							40-40-40	027013040	44,93
					8	25 - 1	027090254	8,82									
					8	32 - 3/4	027090323	8,14									
					8	32 - 1	027090324	10,31									
	40 - 1 1/4	027090401	21,91														
 <p>RACOR FIJO HEMBRA</p>					40	16 - 1/2	027027072	3,30	 <p>TE HEMBRA</p>					16	16 - 1/2	027013072	5,91
					35	20 - 1/2	027027022	3,53						12	20 - 1/2	027013022	6,64
					30	20 - 3/4	027027023	4,31						10	20 - 3/4	027013023	7,62
					20	25 - 1/2	027027082	4,76						8	25 - 1/2	027013082	9,44
					20	25 - 3/4	027027073	5,30						7	25 - 3/4	027013073	11,20
					12	25 - 1	027027074	7,23						5	25 - 1	027013074	12,82
					12	32 - 1	027027054	7,47						4	32 - 3/4	027013053	12,88
						40 - 1 1/4	027027075	15,60						3	32 - 1	027013054	15,12
					40 - 1 1/4	027013055	40,00										
 <p>CODO PLACA</p>					14	16 - 1/2	027094162	6,09	 <p>CODO</p>					32	16 - 16	027009016	3,19
					12	20 - 1/2	027094202	6,71						22	20 - 20	027009020	4,46
					10	20 - 3/4	027094203	8,51						11	25 - 25	027009025	7,79
						25 - 3/4	027094253	8,60						6	32 - 32	027009032	11,38
								40 - 40	027009040	29,96							





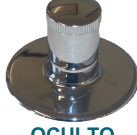



















MULTICAPA ISOLTUBEX (Mordaza Perfil RF)

	□	MEDIDA	REF.	€		□	MEDIDA	REF.	€
	48	16 - 1/2	027035972	3,22		50	16 - 1/2	027024372	2,86
	30	20 - 1/2	027035922	3,63			16 - 3/4	027024383	4,00
	24	20 - 3/4	027035923	5,19		40	20 - 1/2	027024322	3,27
	20	25 - 1/2	027035982	7,32		35	20 - 3/4	027024323	4,34
	18	25 - 3/4	027035973	8,00		20	25 - 1/2	027024382	4,56
	14	25 - 1	027035974	11,00		18	25 - 3/4	027024373	5,03
	14	32 - 1	027035954	12,52		16	25 - 1	027024374	6,61
	45	16 - 16	027027016	2,47		50	15-16	027028098	2,30
	30	20 - 20	027027020	3,48		30	18-20	027028099	3,40
	15	25 - 25	027027025	6,30		20	22-25	027028100	4,31
	10	32 - 32	027027032	8,31					
		40 - 40	027027040	20,41					
	37	20 - 16	027024047	3,54		20	16-20-16	027006729	5,50
	20	25 - 16	027024077	5,12		14	20-16-16	027006277	5,26
	20	25 - 20	027024072	5,23		18	20-16-20	027006272	5,55
	12	32 - 20	027024052	6,95			20-20-16	027006227	6,28
		32 - 25	027024057	7,56			20-25-20	027006282	9,71
		40 - 32	027024045	18,40			25-16-16	027006777	6,94
	25	16 x 1/2	027092162	4,56		9	25-16-25	027006767	9,34
		20 x 1/2	027092202	5,19		9	25-20-16	027006727	7,48
		20 x 3/4	027092034	6,20		10	25-20-20	027006722	8,66
	12	25 x 3/4	027092253	8,09		8	25-20-25	027006728	10,80
						7	25-25-20	027006772	10,23
	8	16 x 1/2	027019001	7,87		5	25-32-25	027006757	14,49
	8	20 x 1/2	027019002	8,05		5	32-25-25	027006577	13,38
						5	32-20-32	027006525	13,44
					5	32-25-32	027006575	13,74	
					5	32-32-25	027006557	14,67	
							027019003	3,49	

MULTICAPA ISOLTUBEX

	MEDIDA	REF.	€		MEDIDA	REF.	€		
 CALIBRADOR	16 x 18 x 20	027028030	18,00	 EMPOTRAR PLADUR	5	16	027039916	14,21	
	20 x 25 x 32	027028035	20,00		5	20	027039920	14,70	
 MUELLE	Exterior	16	027028016	11,41	 EMPOTRAR	5	16	027040016	12,18
		20	027028020	13,65		5	20	027040020	13,40
		25	027028025	15,28		5	25	027040025	18,83
	16	027050016	8,15	32		32	027040032	20,61	
	Interior	20	027050020	8,81	 U PLADUR	4	16U	027039816	20,83
		25	057050025	9,73		4	20U	027039820	21,00
		32	027050032	14,86		4	25U	027039825	22,90
	 VISTA					 KIT ALARGADERA MONTURA	4	20U	027040120
					4		25U	027040125	20,70
					 PROLONGADOR VÁLVULA				
			5	16	027045016		10,11		
 COLECTOR CON EUROCONOS 16	1"-2 SALIDAS	027201212	18,00	5	20	027045020	10,86		
	1"-3 SALIDAS	027201312	21,00	5	25	027045025	17,49		
 TAPÓN RECUPERABLE	48	16	027029016	4	32	027045032	20,46		
				 PALANCA					
 LUBRICANTE				5	PALANCA		027050001	7,48	
				 OCULTO					
			 PALANCA NEGROS						
			 OCULTO						
			5	OCULTO	027050002	6,41			
			5	PALANCA	027050000	7,90			
			5	OCULTO	027050003	6,90			

POLIETILENO RETICULADO

MEDIDA				REF.	€	MEDIDA				REF.	€	
												
16x2	100MTS.			627050016	1,37	20	16-16-16			027513016	4,14	
20x2	100MTS			627050020	1,88	14	20-20-20			027513020	5,49	
25x2,5	50MTS			627050025	2,55	6	25-25-25			027513025	9,94	
32x3	50 MTS.			627050032	4,61	4	32-32-32			027513032	14,34	
												
200	16 x 2			627050216	1,44	16	16 - 1/2			027513013	4,93	
140	20 x 2			627050220	2,03	12	20 - 1/2			027513014	6,32	
80	25 x 2,5			627050225	2,67	10	20 - 3/4			027513015	6,99	
56	32 x 3			627050232	4,68	8	25 - 1/2			027513017	7,85	
												
30	16 - 1/2			027509001	3,60	32	16 - 16			027509016	3,14	
22	20 - 1/2			027509003	4,50	22	20 - 20			027509020	4,01	
15	20 - 3/4			027509004	4,87	11	25 - 25			027509025	6,80	
12	25 - 1/2			027509005	5,96	6	32 - 32			027509032	10,61	
10	25 - 3/4			027509006	6,35							
8	25 - 1			027509007	7,95	50	16 - 1/2			027524301	2,61	
8	32 - 1			027509008	9,47	40	20 - 1/2			027524303	2,81	
												
40	16 - 1/2			027527001	2,68	35	20 - 3/4			027524304	3,86	
35	20 - 1/2			027527002	3,34	16	25 - 1/2			027524305	4,22	
30	20 - 3/4			027527003	4,03	18	25 - 3/4			027524306	4,54	
20	25 - 1/2			027527004	4,37	16	25 - 1			027524307	6,12	
20	25 - 3/4			027527005	4,80	12	32 - 3/4			027524308	5,83	
12	25 - 1			027527006	6,46	14	32 - 1			027524309	6,76	
12	32 - 1			027527008	6,79							
												
14	16 - 1/2			027509009	5,46	5	16			027540016	11,65	
12	20 - 1/2			027509010	6,22	5	20			027540020	12,54	
												
45	16 - 16			027527016	2,49	5	25			027540025	18,94	
30	20 - 20			027527020	3,56	4	32			027540032	24,01	
15	25 - 25			027527025	5,56							
10	32 - 32			027527032	7,62	5				027050001	7,48	
												
37	20 - 16			027524001	2,66	5				027050002	6,41	
20	25 - 16			027524002	4,01							
20	25 - 20			027524003	4,89	18	20-16-16			027513002	4,43	
12	32 - 20			027524005	6,31	14	20-16-20			027513003	5,05	
						18	20-20-16			027513004	5,26	
16				027029016	3,76	9	25-20-16			027513006	6,55	
						10	25-20-20			027513007	7,34	
						8	25-20-25			027513008	8,69	
						7	25-25-20			027513009	8,69	
						5	32-25-25			027513010	11,71	
						5	32-25-32			027513011	12,68	
						5	32-32-25			027513012	13,68	

MULTICAPA MULTISTANDARD (Mordaza Perfil U)

MEDIDA			REF.	€	MEDIDA			REF.	€
	16x2 100MTS.	627540016	244,64		16 - 1/2	027565040	4,84		
	20x2 100MTS	627540020	349,30		20 - 1/2	027565045	5,79		
	25x2,5 50MTS	627540025	281,89		20 - 3/4	027565046	6,34		
	32x3 50 MTS.	627540032	455,61		25 - 3/4	027565049	9,97		
ROLLO									
	16 x 2	627541016	12,34		16 - 1/2	027565020	3,83		
	20 x 2	627541020	16,51		20 - 1/2	027565024	5,68		
	25 x 2,5	627541025	28,50		20 - 3/4	027565025	6,04		
	32 x 3	627541032	46,06		25 - 3/4	027565027	11,44		
BARRA (4mts.)									
	16 - 1/2	027565090	5,23		16 - 16	027565000	4,22		
	20 - 1/2	027565094	6,64		20 - 20	027565002	5,51		
	20 - 3/4	027565095	7,60		25 - 25	027565003	9,52		
	25 - 3/4	027565098	11,19		32 - 32	027565004	15,18		
	32 - 1	027565102	19,78						
CODO HEMBRA									
	16 - 1/2	027565110	8,64		20 - 16	027565011	5,37		
	20 - 1/2	027565113	10,17		25 - 16	027565013	8,17		
CODO BASE FIJACIÓN									
	16-16-16	027565120	6,66		16 - 16	027565060	5,20		
	20-20-20	027565122	9,02		20 - 20	027565062	6,94		
	25-25-25	027565123	16,86		25 - 25	027565063	11,07		
	32-32 -32	027565124	30,52		32 - 32	027565064	18,63		
TE IGUAL									
	16 - 1/2	027565280	5,56		16-20-16	027565131	8,15		
	20 - 1/2	027565282	6,67		20-16-16	027565136	8,15		
	20 - 3/4	027565283	7,30		20-16-20	027565137	8,40		
	25 - 3/4	027565284	11,47		20-20-16	027565142	8,40		
RACOR MÓVIL									
	16 - 1/2	027565170	7,44	25-16-20	027565151	12,81			
	20 - 1/2	027565175	9,63	25-16-25	027565140	12,69			
	20 - 3/4	027565176	8,27	25-20-20	027565153	12,81			
	25 - 3/4	027565179	18,80	25-20-25	027565143	13,36			
	32 - 3/4	027565182	25,98	25-25-20	027565144	13,36			
					32-25-25	027565149	24,74		
				32-20-32	027565148	24,32			
				32-25-32	027565150	24,74			

MULTICAPA MULTISTANDARD (Mordaza Perfil U)

MEDIDA			REF.	€	MEDIDA			REF.	€	
			KIT ALARGADERA MONTURA	027535184	7,20				028035190	6,24
			16 - 16	027635850	17,47					
			20 - 20	027635852	18,56					
			25 - 25	027635854	22,43					
			32 - 32	027635942	28,60					
			16 - 16	027635753	17,76				028035191	7,24
			20 - 20	027635754	22,24					
			25 - 25	027635755	27,98					
			16 - 16	027635650	13,32					
			20 - 20	027635652	14,89					
			25 - 25	027635654	17,02					

MULTICAPA COMPRESIÓN (SIN HERRAMIENTAS)

MEDIDA			REF.	€	MEDIDA			REF.	€		
			16	025964010	4,28				16 x 1/2	025965510	3,98
			20	025964015	6,76				20 x 1/2	025965520	5,76
			25	027227025	13,30				20 X 3/4	025965525	5,98
			25 - 16	025964510	6,20				25 x 3/4	027292253	9,81
			25 - 20	027242520	10,21				16	025965010	4,59
			16 x 1/2	025963010	2,70				20	025965015	6,59
			20 x 1/2	025963020	3,36				25	027209025	11,95
			25 X 3/4	027235253	9,01				16	025960510	6,69
			16 x 1/2	025963510	2,46				20	025960515	10,18
			20 x 1/2	025963520	4,57				25	027213025	21,10
			20 X 3/4	025963525	4,60						
25 x 3/4	027224253	7,98	20 x 1/2	025960020	6,62						

POLIETILENO RET. -PEX-

MEDIDA ROLLO REF. €



PEX-A
PARA FONTANERÍA
<<ROLLO>>

100 mts	16 x 1,8	627049116	1,75
100 mts	20 x 1,9	627049120	2,11
50 mts	25 x 2,3	627049125	3,50
50 mts	32 x 2,9	627049132	5,93

PEX-A
PARA FONTANERÍA
<<BARRA>>

4 mts	16 x 1,8	627049416	1,78
4 mts	20 x 1,9	627049420	2,27
4 mts	25 x 2,3	627049425	3,58
4 mts	32 x 2,9	627049432	6,05

□ MEDIDA REF. €



CODO
MASTER
(PPSU)

32	16 x 16	026909216	1,97
22	20 x 20	026909220	2,27
11	25 x 25	026909225	3,80
6	32 x 32	026909232	7,33



REDUCCION

37	20 x 16	026902016	1,85
20	25 x 20	026902520	2,74
12	32 x 25	026903225	3,95

□ MEDIDA REF. €



TE MASTER
(PPSU)

20	16x16x16	026909116	2,59
14	20x20x20	026909120	3,09
6	25x25x25	026909125	5,88
4	32x32x32	026909132	10,73



LLAVE DE CORTE
DE EMPOTRAR

5	16 x 16	026881600	11,15
5	20 x 20	026882000	11,89
5	25 x 25	026882500	16,66
4	32 x 32	026883200	20,26



TE REDUCIDA
MASTER
(PPSU)

18	20x16x16	026920161	3,25
14	20x16x20	026920162	3,57
18	20x20x16	026920201	3,46
10	25x20x20	026925202	5,21
8	25x20x25	026925205	5,90
7	25x25x20	026925252	6,42
5	32x20x32	026932203	8,19
5	32x25x32	026932253	8,73
5	32x25x25	026932255	8,26



MANETA VISTA

5	027050001	7,48
---	-----------	------



MANGUITO
UNIÓN MASTER
(PPSU)









45	16 x 16	026909016	1,06
30	20 x 20	026909020	1,58
15	25 x 25	026909025	2,58
10	32 x 32	026909032	4,47

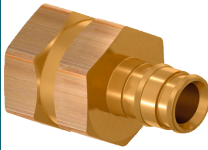

MANETA OCLTA

5	027050002	6,41
---	-----------	------

POLIETILENO RET. -PEX-

	□	MEDIDA	REF.	€		□	MEDIDA	REF.	€	
 <p>TE R/H</p>	16	16 x 1/2"	026831612	4,11	 <p>RACOR FIJO HEMBRA</p>	40	16 x 1/2"	026851612	1,95	
	12	20 x 1/2"	026832012	5,16		40	20 x 1/2"	026852012	2,34	
	8	25 x 1/2"	026832512	7,10		35	20 x 3/4"	026852034	2,99	
	7	25 x 3/4"	026832534	7,82		16	25 x 1"	026852510	5,23	
	3	32 x 1"	026833210	12,65		18	25 x 3/4"	026852534	3,77	
						14	32 x 1"	026853210	7,80	
 <p>CODO BASE FIJACION CORTO</p>	14	16 x 1/2"	026811612	5,08	 <p>RACOR MOVIL</p>	48	16 x 1/2"	026861612	2,89	
	12	20 x 1/2"	026812012	5,56		30	20 x 1/2"	026862012	3,32	
						24	20 x 3/4"	026862034	3,71	
						14	25 x 1"	026862510	8,27	
						18	25 x 3/4"	026862534	4,65	
 <p>LLAVE DE CORTE EN "U"</p>	4	16 x 16	026891600	17,08	 <p>UNION COBRE</p>	50	15 - 16	026871516	2,24	
	4	20 x 20	026892000	18,35		45	18 - 20	026871820	2,53	
	4	25 x 25	026892500	21,29		20	22 - 20	026872220	2,74	
 <p>CODO TERMINAL</p>	ROSCA HEMBRA				 <p>ANILLO AZUL</p>	25	16 A	026907016	0,27	
	22	20 x 1/2"	026802012	3,86		25	20 A	026907020	0,31	
	15	20 x 3/4"	026802034	5,16		25	25 A	026907025	0,49	
	10	25 x 3/4"	026802534	5,52		25	32 A	026907032	0,75	
	8	32 x 1"	026803210	8,96						
		ROSCA MACHO				 <p>ANILLO ROJO</p>	50	16 R	026908016	0,27
	25	16 x 1/2"	026821612	2,22	25		20 R	026908020	0,31	
	20	20 x 1/2"	026822012	3,48	25		25 R	026908025	0,49	
					25		32 R	026908032	0,75	
 <p>RACOR FIJO MACHO</p>	50	16 x 1/2"	026841612	1,81						
	40	16 x 3/4"	026841634	2,39						
	40	20 x 1/2"	026842012	2,22						
	35	20 x 3/4"	026842034	2,85						
	16	25 x 1"	026842510	5,20						
	18	25 x 3/4"	026842534	3,63						
	14	32 x 1"	026843210	6,58						

POLIPROPILENO (PP-R)

FASER
(Barra 4 mts)



MEDIDA	SDR	REF.	€
20 x 2,8	7,4	192111100	1,54
25 x 3,5	7,4	192111200	2,25
32 x 4,4	7,4	192111300	3,65
40 x 5,5	7,4	192111400	5,23
50 x 6,9	7,4	192111500	8,26
63 x 8,6	7,4	192111600	13,03
75 x 10,3	7,4	192111700	19,65



MANGUITO

MEDIDA	REF.	€
16	192201116	0,24
20	192201100	0,18
25	192201200	0,29
32	192201300	0,45
40	192201400	0,69
50	192201500	1,23
63	192201600	2,49
75	192201700	4,42
90	192201900	6,71
110	192201101	9,41



CODO PALACA

25 x 1/2"	192268252	2,45
-----------	-----------	------



TE

20	192205100	0,33
25	192205200	0,56
32	192205300	0,86
40	192205400	1,39
50	192205500	2,74
63	192205600	5,19
75	192205700	7,30
90	192205800	13,49
110	192205900	23,31



CODO 90°

16	192203116	0,36
20	192203100	0,03
25	192203200	0,43
32	192203300	0,66
40	192203400	1,31
50	192203500	2,49
63	192203600	4,30
75	192203700	6,33
90	192203990	9,83
110	PPR.C90110	18,83



TE REDUCIDA

25x20x25	192206727	0,48
32x20x32	192206525	0,81
32x25x32	192206575	0,81
40x20x40	192206424	1,26
40x25x40	192206474	1,26
40x32x40	192206454	1,44
50x20x50	192206526	2,60
50x25x50	192206576	2,65
50x32x50	192206555	2,72
50x40x50	192206545	2,79
63x25x63	192206979	5,11
63x32x63	192206959	5,11
63x40x63	192206949	5,11
63x50x63	192206969	5,11
75x50x75	192206253	9,84



CODO 45°









20	192204100	0,21
25	192204200	0,40
32	192204300	0,61
40	192204400	1,15
50	192204500	1,89
63	192204600	3,77
75	192204575	5,79
90	192204590	9,92
110	PPR.C45110	15,48

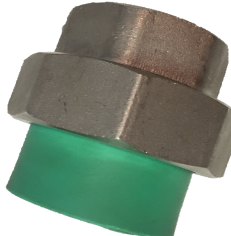

REDUCCIÓN
M-H

20-16	192202016	0,29
25-20	192202210	0,33
32-25	192202320	0,35
40-20	192204020	0,44
40-25	192204025	0,52
40-32	192202430	0,64
50-25	192205025	0,83
50-32	192205032	0,91
50-40	192202540	1,02
63-20	192202632	1,65
63-32	192206332	1,47
63-40	192206340	1,47
63-50	192202650	1,64
75-50	192207550	2,71
75-63	192202760	4,29
90-63	192209063	4,66
90-75	192209075	5,49
110-90	192211090	9,00

POLIPROPILENO (PP-R)

MEDIDA			REF.	€	MEDIDA			REF.	€
	20 x 1/2"	192201110	2,08		20	192288520	5,37		
	20 x 3/4"	192201120	3,07		25	192288525	7,89		
	25 x 1/2"	192201210	2,12		32	192288532	13,06		
	25 x 3/4"	192201220	2,99		40	192288540	25,24		
	32 x 3/4"	192201323	3,93		50	192288550	33,99		
	32 x 1"	192203330	5,83		63	192288563	52,98		
	40x 1 1/4"	192203440	10,36		75	192288575	77,55		
	50x 1 1/2"	192203550	13,01						
	63 x 2"	192203660	19,57						
	75x 2 1/2"	192203770	43,02						
ENTROQUE R/H				VÁLVULA BOLA					
	20 x 1/2	192205110	2,15		20 x 1/2"	192259202	5,85		
	25 x 1/2	192205210	2,29		20 x 3/4"	192259203	6,57		
	25 x 3/4	192205220	3,16		25 x 1/2"	192259252	6,18		
	32 x 3/4	192205323	4,22		25 x 3/4"	192259253	7,79		
	32 x 1"	192205330	6,40		25 x 1"	192259254	7,90		
					32 x 1"	192259324	11,69		
			40 x 1" 1/4		192259405	23,38			
			50 x 1" 1/2		192259506	35,08			
			63 x 2"	192259637	65,98				
CODO R/H				RACOR LOCO					
	16 x 1/2	192202162	3,07		50	192268050	1,35		
	20 x 1/2	192202110	2,33		63	192268063	1,82		
	20 x 3/4	192202120	3,48		75	192268075	3,63		
	25 x 1/2	192202211	2,41		90	192268090	5,31		
	25 x 3/4	192202220	3,44		110	192268110	8,42		
	32 x 1"	192214330	7,79						
	40 x 1" 1/4	192214440	13,66						
	50 x 1" 1/2	192214550	17,04						
	63 x 2"	192214630	28,05						
	75 x 2" 1/2	192214758	54,12						
90 x 3"	192214759	90,11							
ENROQUE R/M				PORTA BRIDA					
	65	028524947	4,35		50	192269050	14,80		
	80	028524948	4,90		63	192269063	19,13		
	100	028524949	6,30		75	192269075	22,87		
	125	028524950	7,85		90	192269090	24,52		
	150	028524951	10,70		110	192269110	28,45		
JUNTA PLANA				BRIDA ACERO					
	20 x 1/2	192207111	2,35						
	25 x 1/2	192207212	2,53						
	25 x 3/4	192207222	3,26						
	32 x 3/4	192207323	4,66						
TE R/H									

POLIETILENO METAL PN 25

		MEDIDA	REF.	€			MEDIDA	REF.	€
<p>MANGUITO DOBLE BRIDAS</p>	20 x 20	022283074	5,24	<p>CODO MACHO</p>	1/2" x 20	022283117	4,22		
	25 x 25	022283075	6,90		3/4" x 25	022283118	6,07		
	32 x 32	022283076	10,77		1" x 32	022283119	10,67		
	40 x 40	022283077	17,86		1 1/4"x40	022283120	15,20		
	50 x 50	022283078	25,66		1 1/2"x50	022283121	25,72		
	63 x63	022283079	42,84		2" x 63	022283122	38,01		
	75 x 75	022268080	102,28						
<p>MANGUITO MACHO BRIDAS</p>	1/2" x 20	022283062	3,16	<p>CODO HEMBRA BRIDAS</p>	1/2" x 20	022283126	4,10		
	3/4" x 25	022283063	4,59		3/4" x 25	022283127	5,84		
	1" x 32	022283064	7,16		1" x 32	022283128	9,63		
	1 1/4"x40	022283065	11,22		1 1/4"x40	022283129	14,46		
	1 1/2"x50	022283066	16,08		1 1/2"x50	022283130	28,62		
	2" x 63	022283067	25,80		2" x 63	022283131	39,21		
	2 1/2x75	022268075	58,50		2 1/2x75	022268091	90,53		
3" x 90	022268076	97,40							
<p>MANGUITO HEMBRA BRIDAS</p>	1/2" x 20	022283050	3,36	<p>CODO PLACA</p>	20 x 1/2	022283202	4,31		
	3/4" x 25	022283051	4,75		25 x 3/4	022283225	6,46		
	1" x 32	022283052	6,94	<p>TE IGUAL BRIDAS</p>	20x20x20	022283092	8,18		
	1 1/4"x40	022283053	10,84		25x25x25	022283093	12,64		
	1 1/2"x50	022283054	16,52		32x32x32	022283094	18,59		
2" x 63	022283055	26,68	40x40x40		022283095	28,58			
2 1/2x75	022268070	61,21	50x50x50		022283096	46,36			
<p>CODO BRIDAS</p>	20 x 20	022284200	5,92	<p>TE HEMBRA BRIDAS</p>	20 x 1/2" x 20	022283104	6,37		
	25 x 25	022284201	9,13		25 x 3/4" x 25	022283105	10,19		
	32 x 32	022284202	13,40		32 x 1" x 32	022283106	15,18		
	40 x 40	022284203	21,13		40 x 1 1/4" x 40	022283107	24,38		
	50 x 50	022284204	35,40		50 x 1 1/2" x 50	022283108	38,16		
	63 x63	022284205	53,32		63 x 2" x 63	022283109	64,95		
	75 x 75	022268085	143,25		75 x 2 1/2 x 75	022268097	219,88		

POLIETILENO BARRA

		MEDIDA	REF.	€/Metro			MEDIDA	REF.	€/Metro
<p>ALIMENTARIO PE 100</p>	20x20 Atm	4 mts.	621120020	1,25	<p>* Barras de 6 mts.</p>	Atm	90x16	621116090	15,06
	25x20 Atm	4 mts.	621120025	2,00			110x16	621116110	21,36
	32x16 Atm		621116032	1,91			125x16	621116125	27,60
	40x16 Atm		621116040	3,07			160x16	621116160	45,16
	50x16 Atm		621116050	4,71			200x16	621116200	70,37
	63x16 Atm		621116063	7,46					
	75x16Atm		621116075	10,40					

POLIETILENO PLASTICO (FITTING)

	□	MEDIDA	REF.	€		□	MEDIDA	REF.	€
	40	20 x 1/2"	460824320	2,37		25	20 x 1/2"	460890012	5,00
	50	25 x 3/4"	460824325	2,97		30	25 x 3/4"	460890034	5,74
	25	32 x 1"	460824332	4,75		20	32 x 1"	460890001	7,24
	15	40 x 1 1/4"	460824340	6,35		25	40 x 1 1/4"	460890114	9,04
	10	50 x 1 1/2"	460824350	8,49		15	50 x 1 1/2"	460890112	13,52
	9	63 x 2"	460824363	12,87		12	63 x 2"	460890002	16,58
5	75 x 2 1/2"	460824375	22,67						
	25	20 x 1/2"	460827020	2,91		35	20	460890020	3,84
	25	25 x 3/4"	460827025	3,68		45	25	460890025	4,65
	10	32 x 1"	460827032	4,86		25	32	460890032	6,80
	16	40 x 1 1/4"	460827040	6,71		15	40	460890040	10,36
	10	50 x 1 1/2"	460827050	9,25		15	50	460890050	14,97
	15	63 x 2"	460827063	13,74		8	63	460890063	22,53
5	75 x 2 1/2"	460827075	24,60	5	75	460890075	40,07		
					5	90	460890090	66,71	
	50	20	460824020	3,84		25	20	460813020	5,82
	50	25	460824025	4,65		25	25	460813025	6,98
	16	32	460824032	6,60		8	32	460813032	9,93
	20	40	460824040	10,36		20	40	460813040	15,49
	15	50	460824050	14,97		10	50	460813050	22,61
	6	63	460824063	22,57		5	63	460813063	34,01
5	75	460824075	38,82	5	75	460813075	66,71		
5	90	460824090	64,67	5	90	460813090	100,94		
	12	25 x 20	460824001	4,65		20	460829020	3,09	
	10	32 x 25	460824002	6,63		25	460829025	3,46	
	25	40 x 32	460824003	10,36		32	460829032	5,38	
				40		460829040	6,68		
	20	20 x 1/2"	460892020	3,86		15	20 x 1/2"	460813012	4,88
	12	25 x 3/4"	460892025	4,73		20	25 x 3/4"	460813034	6,86
	20	32 x 1"	460892032	6,00		9	32 x 1"	460813001	9,45
	25	40 x 1 1/4"	460892040	7,82		25	40 x 1 1/4"	460813114	12,27
	15	50 x 1 1/2"	460892050	10,67		15	50 x 1 1/2"	460813112	17,79
	10	63 x 2"	460892063	16,25		4	63 x 2"	460813002	27,94
3	75 x 2 1/2"	460892075	32,47	5	75 x 2 1/2"	460813212	49,16		
	-	1/2	460828002	0,80		20	20 x 1/2"	460847120	6,32
	100	3/4	460828003	1,26		10	25 x 3/4"	460847125	6,98
	100	1"	460828004	1,77		-	32 x 1"	460847132	9,93
	100	3/4 x 1/2	460828032	1,26		60	M3/4xH1/2	460828134	1,46
	100	1" x 3/4	460828043	1,77		100	M1"xH3/4	460828143	1,77

TUBERÍA POLIETILENO (Rollo)



ALIMENTARIO

	MEDIDA	REF.	€/Metro	
	20 x 10 atm.	PE40	621210020	1,29
	25 x 10 atm.	PE40	621210025	2,02
	32 x 10 atm.	PE40	621210032	3,18
	40 x 10 atm.	PE100	621210040	2,07
	50 x 10 atm.	PE100	621210050	3,23
	63 x 10 atm.	PE100	621210063	5,10
	75 x 10 atm.	PE100	621210075	7,19
	90 x 10 atm.	PE100	621210090	10,33

POLIETILENO ELECTROSOLDABLE

	MEDIDA	REF.	€		MEDIDA	REF.	€
 CODO 90°	40	028512095	9,82	 LIMPIADOR PE	500 ml	040420510	5,73
	50	028512097	12,86				
	63	028512099	13,69				
	75	028512101	22,86				
	90	028512103	23,57				
	110	028512105	33,45				
 CODO 45°	40	028512094	9,82	 REDUCCIÓN	63 x 40	028515390	8,69
	50	028512096	12,59		63 x 50	028512072	8,69
	63	028512098	13,69		75 x 63	028515563	12,06
	75	028512100	22,86		90 x 63	028515392	15,42
	90	028512102	23,57		110 x 90	028515693	21,55
	110	028512104	33,45				
	 TE 90°	40	028512162		11,01	 MANGUITO PORTABRIDA	63
50		028512163	12,38	75	028513075		6,96
63		028512164	14,05	90	028513090		7,09
75		028512165	23,99	110	028513110		8,89
90		028512166	24,40				
110		028512167	41,37				
 MANGUITO	40	028512663	3,31	 BRIDA PN10 * 8 taladros	DN 65 (2 1/2")	028524008	67,90
	50	028512664	4,27		DN 80 (3")	028524017	69,27
	63	028512665	4,59		*DN 100 (4")	028524010	89,00
	75	028512666	8,74		*DN 125 (5")	028524011	66,05
	90	028512667	9,17		*DN 150 (6")	028524012	83,35
	110	028512668	11,41				
	125	028512669	15,89				
	160	028512670	23,73				
	200	028512671	41,19				
 ENLACE R/M	32 x 1"	028516152	20,34	 JUNTA PLANA	65	028524947	4,35
	40 x 1 1/4"	028516153	27,56		80	028524948	4,90
	50 x 1 1/2"	028516154	34,78		100	028524949	6,30
	63 x 2"	028516155	45,93		125	028524950	7,85
	75 x 2 1/2"	028516151	83,66		150	028524951	10,70
 ENLACE R/H	32 x 1"	028516156	20,34	 TORNILLO	M-16x60	028524811	2,59
	40 x 1 1/4"	028516157	27,56		M-16x80	028524812	3,26
	50 x 1 1/2"	028516158	34,78		M-16x110	028524814	4,31
	63 x 2"	028516159	45,93		M-16x130	028524815	4,86
	75 x 2 1/2"	028516160	83,66				
 VALV. MARIPOSA FE	65	028504103	64,90	 TUERCA	028524810	0,44	
	80	028504104	71,73				
	100	028504105	92,00				
	125	028504106	127,41				











Solución C-80

Portarrollo con llave de escuadra













REF. 12010080

POLIBUTILENO

MEDIDA			REF.	€	MEDIDA			REF.	€
 <p>TUBERÍA ROLLO (25mts)</p>				15	628016022	93,99	 <p>MANDO OCULTO</p>		
				22	628016025	155,35			
 <p>TUBERÍA BARRA (6 mtrs.)</p>				15	628026001	22,68	 <p>MANDO PALANCA</p>		
				22	628026003	38,25			
 <p>VALV. ESF. EMP. "U"</p>				15	028060420	19,58	 <p>MANDO TRIANGULAR</p>		
				22	028060421	27,58			
 <p>VALV. ESF. EMP.</p>				15	028060410	24,69	 <p>CASQUILLO</p>		
				22	028060412	27,55			
				22			22	028060267	0,38
 <p>VALV. ESF. PALANCA</p>				15	028060400	24,70	 <p>SOPRTE DISTANCIADOR</p>		
				22	028060402	27,70			

POLIBUTILENO

	MEDIDA	REF.	€		MEDIDA	REF.	€
 <p>CODO 90° HH</p>	16	028060051	3,80	 <p>CODO R/H</p>	15 - 1/2	028060240	9,66
	22	028060052	4,83		22 - 1/2	028060241	11,54
					22 - 3/4	028060249	11,90
 <p>TAPÓN H</p>	15	028060216	3,17	 <p>MANGUITO R/M</p>	15 x 1/2	028060132	7,54
					22 x 1/2	028060131	10,19
					22 x 3/4	028060133	8,93
 <p>MANGUITO RECTO HH</p>	15	028060041	3,12	 <p>CODO PLACA</p>	15 x 1/2	028060245	11,16
	22	028060042	4,22		22 x 1/2	028060246	14,83
 <p>TE REDUCIDA</p>	22.15.15	028060086	7,00	 <p>MANGUITO R/H</p>	15 x 1/2	028060142	8,53
	22.22.15	028060071	7,56		22 x 3/4	028060144	10,53
	22.15.22	028060076	7,14				
	15.22.15	028060090	7,67				
 <p>TE IGUAL</p>	15	028060066	5,58	 <p>TE R/H</p>	15 x 1/2	028060252	13,55
	22	028060067	7,29		22 x 1/4	028060253	15,03

HIERRO



CODO H-H

MEDIDA	REF.	€
3/8"	021800901	3,01
1/2"	021800902	1,89
3/4"	021800903	2,65
1"	021800904	4,11
1 1/4"	021800905	7,53
1 1/2"	021800906	9,70
2"	021800907	14,83
2 1/2"	021800908	50,30
3"	021800909	77,04



CODO M-H

MEDIDA	REF.	€
1/2"	021800922	2,43
3/4"	021800923	2,93
1"	021800924	4,90
1 1/4"	021800925	9,33
1 1/2"	021800926	12,60
2"	021800927	18,16
2 1/2"	021800928	58,33
3"	021800929	87,19



MANGUITO

MEDIDA	REF.	€
3/8"	021802701	2,84
1/2"	021802702	1,86
3/4"	021802703	2,30
1"	021802704	3,88
1 1/4"	021802705	5,45
1 1/2"	021802706	7,34
2"	021802707	11,81
2 1/2"	021802708	40,99
3"	021802709	53,20
4"	021802711	108,23



ENLACE 3P H-H

MEDIDA	REF.	€
1/2"	021803402	11,31
3/4"	021803403	13,88
1"	021803404	16,74
1 1/4"	021803405	23,79
1 1/2"	021803406	30,85
2"	021803407	43,45
2 1/2"	021803408	101,71
3"	021803409	149,71



MACHÓN

MEDIDA	REF.	€
3/8"	021802801	3,44
1/2"	021802802	1,94
3/4"	021802803	2,23
1"	021802804	3,05
1 1/4"	021802805	5,83
1 1/2"	021802806	7,28
2"	021802807	11,69
2 1/2"	021802808	35,43
3"	021802809	55,08



ENLACE 3P M-H

MEDIDA	REF.	€
3/8"	021803411	13,35
1/2"	021803412	12,63
3/4"	021803413	16,23
1"	021803414	19,98
1 1/4"	021803415	27,10
1 1/2"	021803416	36,70
2"	021803417	51,56
2 1/2"	021803418	130,44
3"	021803419	210,93



TAPA

MEDIDA	REF.	€
3/8"	021803001	2,38
1/2"	021803002	2,30
3/4"	021803003	2,89
1"	021803004	3,66
1 1/4"	021803005	6,81
1 1/2"	021803006	7,96
2"	021803007	13,10
2 1/2"	021803008	29,73
3"	021803009	33,55



TAPÓN

MEDIDA	REF.	€
3/8"	021802901	1,96
1/2"	021802902	1,43
3/4"	021802903	1,94
1"	021802904	2,48
1 1/4"	021802905	4,91
1 1/2"	021802906	6,60
2"	021802907	10,03
2 1/2"	021802908	23,60
3"	021802909	29,93



TE

MEDIDA	REF.	€
3/8"	021801301	4,21
1/2"	021801302	2,65
3/4"	021801303	3,93
1"	021801304	5,89
1 1/4"	021801305	10,94
1 1/2"	021801306	14,33
2"	021801307	21,66
2 1/2"	021801308	74,34
3"	021801309	87,19
4"	021801310	156,69



MANGUITO REDUCCIÓN H/H
FIG 240

MEDIDA	REF.	€
1/2 x 3/8"	021804021	3,15
3/4" x 1/2"	021804032	3,44
1 x 1/2"	021804042	4,80
1 x 3/4"	021804043	4,45
1 1/4 x 1/2"	021804052	10,60
1 1/4 x 3/4"	021804053	8,50
1 1/4 x 1"	021804054	8,50
1 1/2 x 1/2"	021804062	14,55
1 1/2 x 3/4"	021804063	13,70
1 1/2 x 1"	021804064	9,86
1 1/2 x 1 1/4"	021804065	10,25
2 x 1"	021804074	20,24
2 x 1 1/4"	021804075	18,36
2 x 1 1/2"	021804076	16,03
2 1/2 x 1 1/2"	021804086	54,15
2 1/2 x 2"	021804087	47,11
3 x 2"	021804097	70,20
3 x 2 1/2"	021804098	70,20



TURECA DE REDUCCIÓN M/H
FIG 241

MEDIDA	REF.	€
1/2 x 3/8"	021804121	1,96
3/4" x 1/2"	021804132	2,04
1 x 1/2"	021804142	3,11
1 x 3/4"	021804143	3,11
1 1/4 x 1/2"	021804152	5,20
1 1/4 x 3/4"	021804153	5,14
1 1/4 x 1"	021804154	4,80
1 1/2 x 1/2"	021804162	6,75
1 1/2 x 3/4"	021804163	7,13
1 1/2 x 1"	021804164	5,73
1 1/2 x 1 1/4"	021804165	5,61
2 x 1/2"	021804172	14,55
2 x 3/4"	021804173	14,05
2 x 1"	021804174	10,64
2 x 1 1/4"	021804175	9,86
2 x 1 1/2"	021804176	9,86
2 1/2 x 1 1/2"	021804186	29,99
2 1/2 x 2"	021804187	28,60
3 x 2"	021804197	35,64
3 x 2 1/2"	021804198	35,80



Almacén de Fontanería



**FINANCIA
MAQUINARIA
Y/O
HERRAMIENTA**



DESDE 52€/mes, EN SOLO 24 MESES

**PARA MÁS INFORMACIÓN, CONSULTE A SU
AGENTE COMERCIAL O PUNTO DE VENTA**

GEBO

MEDIDA	REF.	€
3/8"	380620001	14,41
1/2"	380620002	14,41
3/4"	380620003	18,12
1"	380620004	20,85
1 1/4"	380620005	26,16
1 1/2"	380620006	34,46
2"	380620007	52,51



TIPO O
MANGUITO

MEDIDA	REF.	€
1/2"	380880081	15,93
3/4"	380880082	18,85
1"	380880083	22,44
1 1/4"	380880084	30,01
1 1/2"	380880085	35,98
2"	380680086	55,70



TIPO T
TÉ ROSCA HEMBRA



TIPO OF MANGUITO BRIDA

2 1/2"	380620008	108,24
3"	380620009	126,83
4"	01.220.02.09	268,58



TAPAPOROS DC
CORTO ACERO

1/2"	380418201	7,25
3/4"	380418202	7,89
1"	380418203	10,50
1 1/4"	380418204	13,19
1 1/2"	380418205	16,15
2"	380418206	21,37
2 1/2" DS	380418007	39,92
3"	380418208	38,98
4"	380418209	55,13



TIPO A
ROSCA MACHO

3/8"	380631001	11,02
1/2"	380631002	11,02
3/4"	380631003	12,35
1"	380631004	13,94
1 1/4"	380631005	19,52
1 1/2"	380631006	23,70
2"	380631007	33,26



TIPO I
ROSCA HEMBRA

3/8"	380632001	11,15
1/2"	380632002	11,15
3/4"	380632003	12,55
1"	380632004	14,01
1 1/4"	380632005	19,92
1 1/2"	380632006	23,83
2"	380632007	34,99



2 1/2"	380631008	65,18
3"	380631009	88,74
4"	380631010	179,72



2 1/2"	380632008	71,81
3"	380632009	93,04
4"	380632010	182,66

TUBERIA DE HIERRO

















TUBERIA
DE HIERRO

MEDIDA	REF.	€/mts NETO	MEDIDA	REF.	€/mts NETO
1/2"	622011111	4,55	1 1/2"	622011115	8,67
3/4"	622011112	3,95	2"	622011116	12,05
1"	622011113	7,85	2 1/2"	622011117	14,67
1 1/4"	622011114	7,59	3"	622011118	20,15











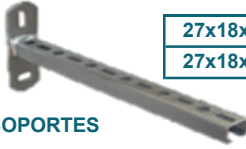

GEBO

MEDIDA			REF.	€	MEDIDA			REF.	€
	1/2"x1/2"	380419201	8,26		15 x 1/2"	381034062	16,92		
	3/4"x1/2"	380419202	9,63		18 x 1/2"	381034092	23,91		
	1"x1/2"	380419203	12,11		22 x 3/4"	381034043	27,74		
	1"1/2x3/4"	380419204	17,60						
ABRAZADERA C/ Toma				RACOR CU / Rosca Macho					
	12	381019012	6,38		15 x 1/2"	381019962	12,83		
	15	381019015	9,24		18 x 1/2"	381019992	13,27		
	18	381019018	9,55		22 x 3/4"	381019942	14,01		
	22	381019022	11,90		28 x 3/4"	381019943	19,53		
	28	381019028	15,32						
TAPAPOROS COBRE				COLLARÍN CU/ Toma					
	16	380622616	9,43		15	381022015	33,44		
	20	380622820	7,76		18	381022018	46,71		
	25	380622825	8,51		22	381022022	48,02		
	32	380622832	11,30						
	40	380622840	14,32						
	50	380622850	19,36						
	63	380622863	24,56						
	75	380622875	45,73						
TAPAPOROS PLÁSTICOS				MANGUITO CU					
	15-21	380255471	35,61		60-67	380660067	75,21		
	21-27	380255472	39,03		73-80	380673080	77,24		
	27-34	380255473	54,43		87-95	380687095	78,02		
	34-39	380255474	75,06		102-112	380610212	82,28		
	39-43	380255475	85,86		108-118	380610818	82,61		
	47-49	380255476	113,93						
	59-61	380255477	121,48						
	ENLACE UNIVERSAL REPARACIÓN MULTIMATERIAL				UNIFIX MAXI				
	63 x 1"	380116820	32,30		88-103	380688103	62,65		
	63 x 2"	380116826	34,95		108-128	380688128	64,31		
	75 x 1"	380116828	36,50		159-182	380688182	101,92		
	75 x 2"	380116834	38,05						
	90 x 1"	380116836	41,70						
	90 x 2"	380116842	44,25						
	110 x 1"	380116844	49,05						
	110 x 2"	380116850	50,20						
	125 x 1"	380116852	63,80						
	125 x 2"	380116858	66,80						
160 x 2"	380116870	85,15							
COLLARÍN FUNDICIÓN AZUL PE/PVC				MULTIDIÁMETRO					

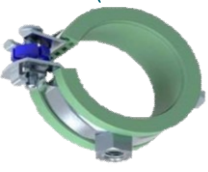
FIJACIÓN, SELLANTES, CLAVADO Y PERFORACIÓN

		□ MEDIDA	REF.	€/mtr.			□ MEDIDA	REF.	€
 <p>ABRAZADERA DOBLE M6</p>	100	12	300260312	0,43	 <p>ISOFÓNICA DOBLE</p>	50	15	300260060	0,92
	100	15	300260316	0,47		50	18	300260061	0,98
	100	18	300260320	0,52		25	22	300260062	1,26
	50	22	300260322	0,59		25	28	300260068	1,57
	25	28	300260328	0,68					
 <p>ABRAZADERA M6</p>	100	10	300260810	0,26	 <p>ABRAZADERA ISOFONICA M6 SIMPLE</p>	100	12	300260012	0,40
	100	12	300260812	0,26		100	15	300260015	0,46
	100	15	300260815	0,27		100	18	300260018	0,48
	100	16	300260816	0,28		100	22	300260022	0,52
	100	18	300260818	0,29		100	28	300260028	0,60
	100	20	300260820	0,30		50	32	300260032	0,71
	100	22	300260822	0,31		50	35	300260035	0,76
	100	25	300260826	0,32		50	40	300260040	0,98
	100	28	300260828	0,34		50	42	300260042	1,00
	50	32	300260832	0,38		50	50	300260050	1,22
	50	35	300260835	0,44		50	54	300260054	1,34
	50	40	300260840	0,47					
	50	42	300260842	0,48					
	50	50	300260850	0,59					
	50	54	300260854	0,71					
	50	63	300260863	0,80					
 <p>SIN FIN</p>	200	8-16	300210516	0,42	 <p>GASMICA</p>	100	12	300260112	0,53
	200	12-20	300210520	0,43		100	15	300260115	0,55
	200	16-25	300210525	0,45		100	18	300260118	0,57
	200	20-32	300210532	0,47		100	22	300260122	0,61
	100	25-40	300210540	0,52		100	28	300260128	0,65
	50	32-50	300210550	0,56		50	35	300260135	0,80
	50	40-60	300210560	0,66		50	42	300160142	0,88
	25	100-120	300210592	1,17					
	25	110-130	300210593	1,23					
	 <p>ALCAYATA (2 uds)</p>	4,5 x 60	300254560	1,82		 <p>CLIP DOBLE M6</p>	50	12	300261612
8 x 65		300250865	1,18	50	14-15		300261615	0,53	
 <p>TIRAFONDO DOBLE ROSCA</p>	100	M.8 x 80	300230880	0,27	 <p>CLIP M6</p>	100	12	300261412	0,29
	100	M.8 x 100	300230810	0,33		100	14-15	300261415	0,32
	50	M.10x100	300231010	0,57		100	16-18	300261418	0,40
	50	M.10x110	300231110	0,58		100	20-22	300261422	0,41
 <p>TUERCA HEXAGONAL</p>	200	M.6	300291006	0,03	 <p>MULTITODO</p>	100	15-18	300232915	0,31
	200	M.8	300290238	0,07		50	20-25	300232920	0,37
	100	M.10	300291010	0,21		50	25-32	300232925	0,49
	100	M.12	300291012	0,30					
 <p>ARANDELA</p>	200	M.6	300293006	0,08	 <p>TIRAFONDO ABRAZADERA</p>	100	M-6 x 30	300260870	0,10
	200	M.8	300293008	0,17		100	M-8 x 40	300280150	0,28
	200	M.10	300293010	0,43					
	50	M.12	300292012	0,19					

FIJACIÓN, SELLANTES, CLAVADO Y PERFORACIÓN

<input type="checkbox"/> MEDIDA REF. €/mtr.				<input type="checkbox"/> MEDIDA REF. €					
 REFORZADA HIERRO M8-M10	50	1/2"	300280443	0,86	 ABARCÓN	50	1"	300214235	0,63
	50	3/4"	300280444	0,92		50	1 1/4"	300214242	0,70
	50	1"	300280445	0,98		30	1 1/2"	300214248	1,31
	50	1 1/4"	300280447	1,08		30	2"	300214260	1,43
	25	1 1/2"	300280448	1,21		20	2 1/2"	300214275	1,95
	25	2"	300280449	1,34		20	3"	300214290	2,10
	25	2 1/2"	300280500	1,36					
	25	3"	300280502	1,50					
	25	4"	300280503	1,70					
	25	5"	300280504	2,23					
25	6"	300280505	2,89						
 INOXIDABLE M8	50	*15	300216015	2,68	 SOPORTES	27x18x20cm	300200272	4,96	
	50	18	300209018	2,50		27x18x30cm	300200273	5,77	
	50	22	300209022	2,67	 SOPORTES	38x40x30cm	300200280	11,49	
	50	28	300209028	2,83		38x40x40cm	300200384	14,00	
	50	35	300209035	3,00		38x40x60cm	300200386	21,88	
	50	42	300209042	3,22					
	50	54	300209054	3,66					
 TIRAFONDOS INOX	100	M-6 x 30	300204630	0,83	 TORNILLO BARRAQUERO	200	8 x 60	300240860	0,29
	100	M-8 x 50	300204850	1,69		100	8 x 80	300240880	0,36
 (GOMA VERDE) PPR ISOFÓNICA M8 - M10	50	20	300259020	1,78	 CINTA PERFORADA	300281350	8,84		
	50	25	300259025	1,96					
	50	32	300259032	2,32					
	50	40	300259040	2,56					
	25	50	300259050	3,30					
	25	63	300259063	4,48					
	25	75	300259075	4,77					
	25	90	300259090	5,05					
 ABRAZADERA ISOFÓNICA M8 - M10	50	22	300281022	0,99	 ABRAZADERA DE CIERRE NYLON	100	15	300211115	0,34
	50	28	300281028	1,09		100	18	300211118	0,39
	50	35	300281035	1,17		100	20	300211120	0,41
	50	40-42	300281040	1,27		100	22	300211122	0,42
	25	48-50	300281048	1,42		100	25	300211125	0,46
	25	54	300281054	1,50		50	28	300211128	0,58
	25	60	300281060	1,59		25	32	300211132	0,66
	25	75	300281075	1,81		25	35	300211135	0,78
	25	90	300281090	1,97		25	40	300211140	0,91
	25	110	300281110	2,52		25	50	300211150	1,24
	25	125	300281125	2,88					
	25	160	300281160	3,73					
	25	200	300281200	4,52					
	25	250	300281250	5,72					
	25	315	300281315	7,53					
 PVC	25	75	300280975	2,21	 GUÍ AMETÁLICA (2 metros)	20 x 10	300211399	6,50	
	25	90	300280990	2,20		28 x 30	300212830	20,06	
	25	110	300280110	2,18		38 x 40	300213840	30,33	
	25	125	300280125	2,30		40 x 20	300214020	16,06	
	25	160	300280160	3,38					
	20	200	300280200	4,21					
	20	250	300280250	7,51					
	20	315	300280315	10,30					
	-	315	300280315	10,30					

FIJACIÓN, SELLANTES, CLAVADO Y PERFORACIÓN

MEDIDA				REF.	€/mtr.	MEDIDA				REF.	€																								
<p>JUEGO TORNILLOS LAVABO</p>						M-10x110	300290210	2,92	<p>BRIDAS NYLON (100 uds.)</p> <table border="1"> <tr><td>2,5x100</td><td>300281251</td><td>1,80</td></tr> <tr><td>3,6x200</td><td>300281362</td><td>3,60</td></tr> <tr><td>3,6x290</td><td>300281390</td><td>5,50</td></tr> <tr><td>4,8x200</td><td>300281482</td><td>4,50</td></tr> <tr><td>4,8x300</td><td>300281483</td><td>7,20</td></tr> <tr><td>4,8x360</td><td>300281486</td><td>8,80</td></tr> <tr><td>Taco brida</td><td>300281490</td><td>5,90</td></tr> </table>						2,5x100	300281251	1,80	3,6x200	300281362	3,60	3,6x290	300281390	5,50	4,8x200	300281482	4,50	4,8x300	300281483	7,20	4,8x360	300281486	8,80	Taco brida	300281490	5,90
						2,5x100	300281251	1,80																											
3,6x200	300281362	3,60																																	
3,6x290	300281390	5,50																																	
4,8x200	300281482	4,50																																	
4,8x300	300281483	7,20																																	
4,8x360	300281486	8,80																																	
Taco brida	300281490	5,90																																	
<p>JUEGO TRONILLOS TERMOS</p>						8 x 60	300290212	1,22																											
						<p>HYDRAFIX</p> <table border="1"> <tr><td>300</td><td>6 x 30</td><td>300232506</td><td>13,23</td></tr> <tr><td>128</td><td>8 x 40</td><td>300232508</td><td>11,43</td></tr> <tr><td>75</td><td>10 x 50</td><td>300232510</td><td>13,23</td></tr> </table>						300	6 x 30	300232506	13,23	128	8 x 40	300232508	11,43	75	10 x 50	300232510	13,23												
300	6 x 30	300232506	13,23																																
128	8 x 40	300232508	11,43																																
75	10 x 50	300232510	13,23																																
<p>ANCLAJE HEMBRA</p>						100	M-8	300211400	0,19	<p>TORNILLO WC HORIZONTAL</p>						300290225	6,89																		
<p>MANGUITO HEXAGONAL</p>						250	M-6 x 20	300260302	0,31	<p>TEFLON Estrecho</p>						991380550	0,36																		
						100	M-8 x 20	300280308	0,50	<p>TEFLON Ancho</p>						991380551	2,15																		
						100	M-10 x 30	300210310	0,71																										
<p>ESPÁRRAGO</p>						200	M-6 x 20	300260310	0,27	<p>CINTA ADHESIVA NEGRA</p> <table border="1"> <tr><td>20x19mm</td><td>040218437</td><td>1,53</td></tr> <tr><td>33x50mm</td><td>040218425</td><td>13,05</td></tr> </table>						20x19mm	040218437	1,53	33x50mm	040218425	13,05														
20x19mm	040218437	1,53																																	
33x50mm	040218425	13,05																																	
<p>VARILLA</p>						M-6x1000	300290306	1,17	<p>ALUMINIO</p> <table border="1"> <tr><td>10x50mm</td><td>040218403</td><td>2,83</td></tr> <tr><td>50x50mm</td><td>040218439</td><td>6,98</td></tr> </table>						10x50mm	040218403	2,83	50x50mm	040218439	6,98															
						10x50mm	040218403	2,83																											
						50x50mm	040218439	6,98																											
						M-8x1000	300290308	1,80																											
M-10x1000	300290310	3,36																																	
M-12x1000	300290312	4,90																																	
<p>LOCTITE 55</p>						040619998		16,30	<p>BLANCA</p> <table border="1"> <tr><td>5x50mm</td><td>991304234</td><td>4,16</td></tr> <tr><td>50x50mm</td><td>991304235</td><td>8,40</td></tr> </table>						5x50mm	991304234	4,16	50x50mm	991304235	8,40															
5x50mm	991304234	4,16																																	
50x50mm	991304235	8,40																																	

FIJACIÓN, SELLANTES, CLAVADO Y PERFORACIÓN

Polímeros MS

Código	Descripción	Uds. Caja	PVP
040246004	POLÍMERO TOT MS-20 NEGRO 280 ML	25 U.	6,68
040246002	POLÍMERO TOT MS-20 BLANCO 280 ML	25 U.	6,68
040246003	POLÍMERO TOT MS-20 GRIS 280 ML	25 U.	6,68
040246009	POLÍMERO TOT MS-20 TEJA 280 ML	25 U.	6,68
040246801	POLÍMERO TOT MS CRISTAL 300 ML	12 U.	8,76
040246702	POLÍMERO MS RAPID BLANCO 300 ML	12 U.	7,10
040246202	POLÍMERO MS PISCINAS 280 ML		7,18



Impermeabilizantes líquidos

Código	Descripción	Uds. Caja	PVP
040201301	IMPERMEABILIZANTE MS-6000 GRIS 1 KG	6 U.	18,17
040201401	IMPERMEABILIZANTE MS-6000 NEGRO 1 KG	6 U.	18,17
040201701	IMPERMEABILIZANTE MS-6000 BLANCO 1 KG	6 U.	18,17
040201901	IMPERMEABILIZANTE MS-6000 TEJA 1 KG	6 U.	18,17



Siliconas Neutras

Código	Descripción	Uds. Caja	PVP
040242101	SILICONA NEUTRA UNIVER. TRNASL. 280 ML	25 U.	5,85
040242102	SILICONA NEUTRA UNIVER. BLANCA 280 ML	25 U.	5,85



Spray Ignifugo

Código	Descripción	Uds. Caja	PVP
991310904	COLLAK FIRETEC 750 ML		15,10



Siliconas Ácidas

Código	Descripción	Uds. Caja	PVP
991380210	SILICONA FYCE TRANSLUCIDO 280 ML	25 U.	4,14
991380211	SILICONA FYCE BLANCO 280 ML	25 U.	4,14



Espumas de Poliuretano

Código	Descripción	Uds. Caja	PVP
991310388	FOAM PISTOLA 750 ML.	12 U.	8,61
991310386	ESPUMA MANUAL 300 ML.	12 U.	5,87



Lubricante Multiusos

Código	Descripción	Uds. Caja	PVP
991307911	COLLAK ACEITE MULTIUSOS SPRAY 400ml	12 U.	5,40
423060000	STARRETT LUBRIC. MULTIUSO SPRAY 200ml	24 U.	6,42



Taco Químico

Código	Descripción	Uds. Caja	PVP
040248603	TACO QUIMICO		12,87
040233047	BOLSA TAMICES 9x50		5,03
040233048	BOLSA TAMICES 13x85		5,03
040233046	CANULA MEZCLADORA		0,74





Pistolas Silicona









Código	Descripción	Uds. Caja	PVP
420407612	PISTOLA SILICONA		6,26
420407613	PISTOLA SILICONA PROFESIONAL		20,71



VARIOS FONTANERÍA

MEDIDA			REF.	€	MEDIDA			REF.	€																						
 <p>JUNTAS</p>					3/8	480470050	0,10	ATOMIZADORES  <table border="1"> <tr> <td>*Llave Atomizadores</td> <td>240558097</td> <td>10,98</td> </tr> <tr> <td>(Lavabo) M 24/100</td> <td>991305907</td> <td>1,54</td> </tr> <tr> <td>(Lavabo) H 22/100</td> <td>991305905</td> <td>1,44</td> </tr> <tr> <td>(Baño) M 28/100</td> <td>991305906</td> <td>1,83</td> </tr> </table> <p>Con rótula</p> <table border="1"> <tr> <td>HRMBRA</td> <td>991305904</td> <td>3,29</td> </tr> <tr> <td>MACHO</td> <td>991305903</td> <td>3,29</td> </tr> </table>			*Llave Atomizadores	240558097	10,98	(Lavabo) M 24/100	991305907	1,54	(Lavabo) H 22/100	991305905	1,44	(Baño) M 28/100	991305906	1,83	HRMBRA	991305904	3,29	MACHO	991305903	3,29			
					*Llave Atomizadores	240558097	10,98																								
					(Lavabo) M 24/100	991305907	1,54																								
					(Lavabo) H 22/100	991305905	1,44																								
					(Baño) M 28/100	991305906	1,83																								
					HRMBRA	991305904	3,29																								
					MACHO	991305903	3,29																								
					1/2	480470051	0,10																								
3/4	480470052	0,10																													
1"	480470053	0,10																													
1 1/4	480470054	0,20																													
1 1/2	480470055	0,20																													
2"	480470056	0,20																													
ANCHA 1/2	480470062	0,10																													
ANCHA 3/4	480470063	0,10																													
ANCHA 1"	480470064	0,10																													
 <p>DESATASCADOR PROFESIONAL</p>					1 L	991328888	11,50	 <p>DESATASCADOR DOMÉSTICO</p>																							
					1 L	991328889	7,18																								
 <p>CABLE SIERRA</p>						991322735	16,49	 <p>GOMAS</p> <table border="1"> <tr> <td>1 Enxufe 25</td> <td>480450025</td> <td>1,21</td> </tr> <tr> <td>2 Enxufe 30</td> <td>480450030</td> <td>1,31</td> </tr> <tr> <td>3 victoria</td> <td>480450032</td> <td>1,66</td> </tr> <tr> <td>4 Lucerna Larga</td> <td>480450031</td> <td>1,39</td> </tr> </table>			1 Enxufe 25	480450025	1,21	2 Enxufe 30	480450030	1,31	3 victoria	480450032	1,66	4 Lucerna Larga	480450031	1,39									
1 Enxufe 25	480450025	1,21																													
2 Enxufe 30	480450030	1,31																													
3 victoria	480450032	1,66																													
4 Lucerna Larga	480450031	1,39																													
 <p>JUNTA SEMICÓNICA</p>					3/8	480480048	0,75																								
					1/2	480480049	0,75																								
					3/4	480480050	0,75																								
					1"	480480051	0,75																								
					1 1/4	480480052	0,75																								
					1 1/2	480480053	0,75																								
 <p>ARANDELA HIERRO</p>					1/2	991300200	0,27																								
					3/4	991300201	0,32																								
					1"	991300202	0,49																								
					1 1/4	991300203	0,58																								
					1 1/2	991300206	0,75																								
					2"	991300204	1,07																								
 <p>BOLA NYLON</p>					1/2	991310102	4,06																								
					3/4	991310103	5,12																								
					1"	991310104	6,19																								
					1 1/4	991310105	9,40																								
					1 1/2	991310105	9,39																								
					2"	991310107	12,82																								
 <p>CAÑAMO</p>					Madeja	991310905	5,18	 <p>JUNTA PLANA</p> <table border="1"> <tr> <td>3/8</td> <td>480470038</td> <td>0,30</td> </tr> <tr> <td>1/2</td> <td>480470042</td> <td>0,30</td> </tr> <tr> <td>3/4</td> <td>480470043</td> <td>0,30</td> </tr> <tr> <td>1"</td> <td>480470044</td> <td>0,30</td> </tr> <tr> <td>1 1/4</td> <td>480470045</td> <td>0,30</td> </tr> <tr> <td>1 1/2</td> <td>480470046</td> <td>0,30</td> </tr> </table>			3/8	480470038	0,30	1/2	480470042	0,30	3/4	480470043	0,30	1"	480470044	0,30	1 1/4	480470045	0,30	1 1/2	480470046	0,30			
3/8	480470038	0,30																													
1/2	480470042	0,30																													
3/4	480470043	0,30																													
1"	480470044	0,30																													
1 1/4	480470045	0,30																													
1 1/2	480470046	0,30																													
					Bote 80gr.	991310906	2,82																								
 <p>VÁLVULA FLOTADOR QUICK STOP</p>					1/2	390650012	22,77	 <p>FLOTADOR GUIA</p> <table border="1"> <tr> <td>1/2</td> <td>390633005</td> <td>15,84</td> </tr> <tr> <td>3/4</td> <td>390633004</td> <td>25,41</td> </tr> <tr> <td>1"</td> <td>390633006</td> <td>37,84</td> </tr> <tr> <td>1 1/4</td> <td>390633010</td> <td>73,32</td> </tr> <tr> <td>1 1/2</td> <td>390633011</td> <td>87,40</td> </tr> <tr> <td>2"</td> <td>390633012</td> <td>135,74</td> </tr> <tr> <td>2 1/2</td> <td>390633013</td> <td>813,44</td> </tr> </table>			1/2	390633005	15,84	3/4	390633004	25,41	1"	390633006	37,84	1 1/4	390633010	73,32	1 1/2	390633011	87,40	2"	390633012	135,74	2 1/2	390633013	813,44
1/2	390633005	15,84																													
3/4	390633004	25,41																													
1"	390633006	37,84																													
1 1/4	390633010	73,32																													
1 1/2	390633011	87,40																													
2"	390633012	135,74																													
2 1/2	390633013	813,44																													
					3/4	390650018	32,32																								
					1"	390650025	35,12																								
					1 1/4	390650032	38,06																								
					1 1/2	390650040	42,60																								

VARIOS FONTANERÍA

MEDIDA			REF.	€	MEDIDA			REF.	€
	16/150	991365502	9,43		M-H 1/2	991365002	2,92	MANGUITO ELECTRÓLISIS	
	17/150	991365512	10,19		M-H 3/4	991365003	4,19		
	18/150	991365522	10,19		1	991365004	6,53		
	19/150	991365532	10,19		1" 1/4	991365005	19,50		
	20/150	991365542	10,19		1" 1/2	991365006	31,25		
	21/150	991365552	10,19		2"	991365007	44,03		
	22/150	911365562	10,19			2 mts.	991360760		9,04
	23/150	991365572	7,34			1,5 mts.	991360759		7,67
	3/8	991365582	10,19			LAVADORA TUBO CARGA			
	1/2	991365592	10,19				LAVADORA TUBO DESCARGA		
16/150	991365503	10,55	991360761	5,27					
17/150	991365513	14,09		VÁLVULA SEGURIDAD TERMO (10kg)					
18/150	991365523	14,09		1/2	100100291		7,00		
19/150	991365533	14,09		3/4	991390856		11,32		
20/150	991365543	14,09		TACO SX PLUS caja					
21/150	991365553	14,09		*100 uds/caja 6x30	302368006	7,17			
22/150	911365563	14,09	*100 uds/caja 8x40	302368008	10,72				
23/150	991365573	10,84	*50 uds/caja 10x50	302368010	10,24				
3/8	991365583	13,67	*25 uds/caja 12x60	302368012	8,81				
1/2	991365593	14,09		TACO QUÍMICO					
3/4	991365505	15,12		12 x 85	302041901	0,41			
	Spray Triple Protect. Impermeabilizante		302035747	11,80	16 x 85	302041902	0,35		
					TACO QUÍMICO				
					302350636	19,37			
	AEROSOL SPRAY MARCADOR								
	AZUL	040270515	7,40						
	ROJO	040270510	7,40						

AIREADORES

	M-24	240817298	1,96		FLEXIBLE 22/24M	240814698	4,80
	*M-24	240817398	13,40		CON RÓTULA 22/24M	240814798	2,59
	H-22	240817198	1,96		CAJA BOX AIREADORES (21 Piezas)	240814000	48,00
	*H-22	240817399	13,40				
M-24 INCLINABLE	240819398	6,01					

CONEXIONES WC, Lavabos y Bidés

DESCRIPCIÓN	LARGO EN CENTÍMETROS											
	15		20		25		30		40		50	
	REF.	€	REF.	€	REF.	€	REF.	€	REF.	€	REF.	€
Ref.: 24050+												
M 3/8 - H 3/8	1115	2,80	1120	2,94	1125	3,07	1130	3,22	1140	3,55	1150	3,89
H 3/8 - H 3/8	2115	2,80	2120	2,94	2125	3,07	2130	3,22	2140	3,55	2150	3,89
M 1/2 - H 1/2	1215	3,17	1220	3,34	1225	3,46	1230	3,62	1240	3,89	1250	4,29
H 1/2 - H 1/2	2215	3,17	2220	3,34	2225	3,46	2230	3,62	2240	3,89	2250	4,29
H 3/8 - H 1/2	2315	3,17	2320	3,34	2325	3,46	2330	3,62	2340	3,89	2350	4,29

CONEXIONES Termos y calentadores

DESCRIPCIÓN	LARGO EN CENTÍMETROS											
	15		20		25		30		40		50	
	REF.	€	REF.	€	REF.	€	REF.	€	REF.	€	REF.	€
Ref.: 24030+												
M 1/2 - H 1/2	-	-	2212	10,65	2512	7,85	2355	8,16	2356	8,53	2357	9,38
H 1/2 - H 1/2	-	-	-	-	2513	7,85	3330	8,16	4013	8,53	3350	9,38
Ref.: 24020+												
H 3/4 - H 3/4	-	-	4021	13,03	4022	9,18	4015	9,47	4018	9,85	4020	10,72
H 3/4 - H 3/4	-	-	3237	12,92	3238	9,18	4016	9,47	3240	9,85	4050	10,72

CONEXIONES Grupos de Presión

DESCRIPCIÓN	LARGO EN CENTÍMETROS											
	15		20		25		30		40		50	
	REF.	€	REF.	€	REF.	€	REF.	€	REF.	€	REF.	€
Ref.: 24010+												
H 3/4 - H 3/4							6060	15,44	6070	16,74	6080	18,44
M 3/4 - H 3/4	-	-					6030	15,44	6040	16,74	6050	18,44
M 1 - H 1	-	-	6124	5,33	6125	5,71	6130	18,44	6140	21,25	6150	24,62
M 1"1/4 - H 1"1/4									6240	49,53	6250	55,16
M 1"1/2 - H 1"1/2									6340	77,23	6350	84,96
M 2" - H 2"									6440	107,44	6450	114,72

CONEXIONES Grifería

	MEDIDA	REF.	€	
	Cuello corto	10 X 100	240602011	2,93
	Cuello largo	10 x 100	240602012	3,81

CONEXIONES INOXIDABLES Extensibles

	MEDIDA	REF.	€
	H-H 3/8 30 cm	240503830	7,05
	H-H 3/8 40 cm	240503840	7,37
	H-H 3/8 50 cm	240503850	7,86

KIT CALDERAS MURALES

	REF.	€
	160951700	62,00

CONEXIONES A MEDIA



MALETIN

REF.	€/rollo
6500	412,87

MEDIDA	REF.	€/rollo
1/2	240406546	53,30
3/4	240406552	66,73



ROLLO 4 mts.

TUERCAS MEDIDA	REF.	€
1/2	240406481	1,03
3/4	240406482	1,37

ANILLAS MEDIDA	REF.	€
1/2	240406486	0,76
3/4	240406487	0,82

JUNTAS MEDIDA	REF.	€
1/2	240406496	0,38
3/4	240406497	0,50

Válvulas instaladas hace 1 año

sin



NO FUNCIONA

con **VITAQ[®]** SYSTEM A80 mac



FUNCIONA

Elige la gama **VITAQ System** para que tus instalaciones tengan **más vida** y estén **libres de cal**.
ARCO vuelve a revolucionar la fontanería aportando un gran valor añadido a sus clientes.

VITAQ[®]
SYSTEM

15
AÑOS
GARANTÍA



Elige calidad ARCO. No te la juegues.



made in
spain
original

valvulasarco.com

AGUA | GAS | CALEFACCIÓN

ARCO es una industria española con trayectoria familiar de más de 40 años de experiencia. Diseña, produce y distribuye válvulas y sistemas para fontanería, gas y calefacción. Su innovación, calidad y seguridad la sitúan como una marca internacional de referencia en el sector. Es miembro del Foro de Marcas Renombradas Españolas.

blog     

 **arco[®]**
CALIDAD POR TRADICIÓN

MECANISMOS WC

		MEDIDA	€			MEDIDA	€
	1 DESCARGA 1 PULSADOR LOJA			MECANISMOS FYCE MECANISMOS ALIMENTACIÓN DUAL ORIENTABLE DUO 320170004 19,47			
		320170007 17,33					
	PULSADOR LOJA 320170008 3,70						
	2 DESCARGA DOBLE PULSADOR DENIA 320170002 23,60						
	GOMA CIERRE 320170010 1,63						
	TIFON 3G Un Pulsador interrumpible 320430701 14,01			REF. 3/8" 320412028 7,86			
	TIFON 10 Un Pulsador 320429106 12,91			GRIFO VERTICAL GRIFO LATERAL 3/8" 320412024 5,38			
	TIFON 4 Un Pulsador 320430203 10,22			DESCARGA			
	D/PULSADOR 3G 461028500 42,54			JIMTEN ALIMENTACIÓN 2 en 1 LATERAL / INFERIOR			
	D/PULSADOR 2L 461028501 28,60			461046500 19,62			
	GOMA OBTURADORA 461311256 1,71			PULSADOR DOBLE 461045255 14,16			
	DESCARGA 1 PULSADOR ECO 320870301 16,81			PRHIE ALIMENTACIÓN 2 en 1 LATERAL / INFERIOR 320880120 20,08			
	DESCARGA 1 PULS. NEGRO 320870302 16,81			ALTIS 320880100 17,03 FORTIS 320880101 17,03			
	PULSADOR NEGRO ECO 320870303 15,74			DESCARGA DOBLE PULSADOR NIAGARA 320870300 29,96			
	DESCARGA DOBLE PULSADOR NIAGARA 320870300 29,96						

MECANISMOS WC

			MEDIDA	REF.	€				MEDIDA	REF.	€	
 <p>1 Roca 2 Victoria (nuevo)</p>						 <p>CISTERNA DE PLÁSTICO</p>						
							9 litros	991310920	9,33			
							Bajante	991310511	6,21			
							Cisterna					
 <p>3 Tyfon 4 Porsan</p>						 <p>TIRADOR W.C.</p>						
							800 mm.	320611044	3,12			
 <p>JUNTA INODORO PEQ.</p>												
			81 x 55	320412540	1,53							
 <p>JUNTA INODORO</p>												
			100 x 59	320412530	1,50							
 <p>GOMA OBTURADORA</p>												
			Pequeña	320611016	0,71							
			Grande	320611014	0,71							
 <p>DESCARGADOR CISTERNA ALTA</p>												
			DC 262	320611004	9,29							
			DC 026	320611002	2,09							
 <p>CAMPANA CISTERNA ALTA</p>												
 <p>TIRADOR VERTICAL TIPO 5</p>												
			TV5A	320412042	7,03							
 <p>TIRADOR VERTICAL TIPO 4</p>												
			TV4A	320412040	6,57							
 <p>TORNILLOS FIJACIÓN CISTERNA/INODORO</p>												
			RM6x80	320412063	2,18							
 <p>BOLSA MECANISMOS CISTERNA ALTA</p>												
			320611001	18,83								
 <p>PULSADOR TYFON</p>												
			320412034	3,47								

ARCO ESFERA

	MEDIDA	REF.	€	
	10	3/8"Hx3/8"H	100101101	12,15
	25	1/2"Hx1/2"H	100101102	13,05
	20	3/4"Hx3/4"H	100101103	18,84
	10	1"Hx1"H	100101104	28,29
	6	1 1/4"Hx1 1/4"H	100101105	43,31
	4	1 1/2"Hx1 1/2"H	100101106	67,56
	2	2"Hx2"H	100101107	99,10
	2	2 1/2"Hx2 1/2"H	100101108	170,00
	2	3"Hx3"H	100101109	274,55

TAJO 2000

	25	12	100100234	15,99
	25	15	100100238	14,37
	25	18	100100242	14,37
	15	22	100100244	20,22
	10	28	100100246	29,22
	6	35	100100250	52,08

TAJO 2000 SOLDAR

	10	3/8"Hx3/8"H	100101203	11,18
	25	1/2"Hx1/2"H	100101205	9,31
	20	3/4"Hx3/4"H	100101207	13,37
	10	1"Hx1"H	100101209	19,72
	6	1 1/4"Hx1 1/4"H	100101211	34,82
	4	1 1/2"Hx1 1/2"H	100101213	53,60
	2	2"Hx2"H	100101214	77,29
	2	2 1/2"Hx2 1/2"H	100101215	164,85

TURIA 3000

	1/2	401796800	22,56
	3/4	401796801	23,26

CIERRE CERAMICO
EMPOTRAR KANSAS

	5	1/2"H x 1/2"H	100100337	13,40
	5	3/4"H x 3/4"H	100100338	18,67
	5	1"H x 1"H	100100339	23,65

TEXAS ROSCAR

	5	15	100100345	10,66
	5	18	100100347	13,59
	5	22	100100348	19,16
	5	28	100100349	13,92

TEXAS SOLDAR

	MEDIDA	REF.	€	
	25	1/2"	100152002	5,05
	20	3/4"	100152003	7,52

NILE

H - H			
	1/2"	100151103	4,92
	3/4"	100151104	7,31

NILE

M - H				
	25	1/2"	100152603	5,05
	20	3/4"	100152604	7,50
		1"	100152605	11,21

NILE

	25	1/2"	100151053	5,06
	20	3/4"	100151054	7,55
	10	1"	100151055	11,20
	6	1 1/4"	100151066	17,63
	4	1 1/2"	100151067	26,71
	2	2"	100151068	40,86
		2 1/2"	100151069	75,68
		3"	100150110	165,89

SENA

NILE

	1/2"	991393030	3,77
	3/4"	991393031	5,40
	1"	991393032	8,72
	1 1/4"	991393033	12,50
	1 1/2"	991393034	20,76
	2"	991393035	30,00



	-	100108225	3,64
--	---	-----------	------

PROLONGADOR

	(1)	5	100108201	13,72
	MANDO PALANCA			
	(2)	5	100108202	13,72
	MANDO MASTER			
	(3)	5	100108203	7,15
	MANDO OCULTO			

ARCO JARDIN

MEDIDA				REF.	€	MEDIDA				REF.	€
		1/2 - 3/4 - 3/4	30	100100472	17,92			GRIFO CURVO			
		DOBLE						1/2" 1/2"	15	100100401	12,49
		1/2 - 1/2	48	100100460	10,26			1/2" 3/4"	15	100100413	12,49
		1/2 - 3/4	48	100100462	10,40			3/4" 3/4"	10	100100403	17,96
		1/2" 1/2"		100100473	12,50	1" 1"	6	100100405	26,73		
		NANO						GRIFO VINTAGE			
		1/2" 1/2"		100100473	12,50			1/2" 1/2"		100100400	38,29
		1/2" 1/2"		100100473	12,50			GRUPO FYCE			
		1/2" x 3/4"	25	100155503	6,45						

ARCO (GAS)

		LLAVE CON LIMITADOR CAUDAL					
		1/2"M x 1/2"M	360357100	18,52			
		LIMITADOR					
		10	100500005	15,49			
		V-82					
		1/2"M x 1/2"M	45	100500907	11,92		
		V-83					
		3/4"M x 3/4"M	28	100500601	20,29		
		ESCUADRA MARIPOSA					
		7/8"	15	100500514	23,61		
		ESCUADRA PALANCA					
		7/8"	15	100500513	23,21		
		M-M PALANCA					
		3/4"	20	100500523	14,19		
		7/8"	15	100500510	23,21		
		1"	15	100500595	24,16		
		M-M PALANCA					
		1/2"	25	100500516	12,67		
		3/4"	20	100500501	14,20		
		1"	15	100500503	20,40		
		1 1/4"	8	100500505	35,27		
		M-M PALANCA					
		1 1/2"	4	100500507	55,33		

ARCO

	MEDIDA	REF.	€
<p>A-80</p>	3/8 x 3/8	100100701	9,82
	1/2 x 1/2 ECO	991384001	3,13
	FYCE 1/2 x 3/8 ECO	100100901	3,76
	FYCE 1/2 x 3/8 LARGA	100100903	4,38
	1/2 x 1/2 ANTICAL	100100705	9,20
	1/2 x 3/8 ANTICAL	100100704	8,58
	1/2 x 1/2 ANTICAL (THERMO)	100100706	10,18
	1/2 x 3/8 LARGA ANTICAL	100100088	10,00

	MEDIDA	REF.	€
<p>C-80</p>	PORTAROLLO + LLAVE CORTE		
	1/2 x 3/8	120100080	35,00

	MEDIDA	REF.	€
<p>A-80-C</p>	3/8"H x 3/8"	100100715	10,70
	1/2"H x 3/8"	100100716	8,43

	MEDIDA	REF.	€
<p>TWIN</p>	1/2 x 3/8 x 3/8	100100720	24,42

	MEDIDA	REF.	€
<p>COMBI</p>	COMBI	100100732	23,33
	3/8 x 1/2	100100288	1,98
	3/8 x 3/4	100100289	2,44

	MEDIDA	REF.	€
<p>ARCO KIT THERMO XFLOW (LLAVE+CODO)</p>	ADAPTADORES		
	1/2x1/2	100100290	14,87

	MEDIDA	REF.	€	
<p>COMPUERTA CIERRE GOMA</p>	1/2"	21	100101861	7,76
	3/4"	18	100101862	10,11
	1"	12	100101863	17,58
	1 1/4"	6	100101864	27,10
	1 1/2"	3	100101865	38,47
	2"	2	100101866	52,98
	2 1/2"	3	100101867	107,56
	3"	2	100101868	154,68

	MEDIDA	REF.	€	
<p>L-85 LAVADORA</p>	1/2x3/4	60	100100728	8,38
	1/2x3/4		100100904	4,62

	MEDIDA	REF.	€
L-86 LAVADORA		100100729	10,20

	MEDIDA	REF.	€	
<p>VALVULA DE RETENCION</p>	1/2"H x 1/2"H	45	100101701	6,30
	3/4"H x 3/4"H	24	100101702	8,32
	1"H x 1"H	18	100101703	11,03
	1 1/4"H x 1 1/4"H	12	100101704	15,93
	1 1/2"H x 1 1/2"H	6	100101705	22,04
	2"H x 2"H	3	100101706	30,47
	2 1/2"H x 2 1/2"H	2	100101707	77,20

	MEDIDA	REF.	€
<p>VALVULA DERETENCION</p>	3/4"M x 3/4"M	500658010	7,04

	MEDIDA	REF.	€
<p>MINI MACHO-HEMBRA</p>	1/2"M x 1/2"H	100102204	9,06

	MEDIDA	REF.	€	
<p>FILTRO INCLINADO</p>	1/2"	36	100101830	5,64
	3/4"	24	100101831	9,12
	1"	18	100101832	12,87
	1 1/4"	7	100101833	26,34
	1 1/2"	4	100101834	32,69
	2"	2	100101835	48,24

	MEDIDA	REF.	€
<p>SEGURIDAD TERMO</p>	1/2	100100291	7,00





















gebo[®]
www.gebo.es

*Especialistas
en Uniones*



JIMTEN

MEDIDA			REF.	€	MEDIDA			REF.	€														
	S-11		1 1/4 x 63	461011114	11,68		1 1/2	461007112	17,80														
			1 1/2 x 63	461011112	12,01																		
	S-61		1 1/4 x 63	461061114	12,99		1 1/2 x 85	461010112	26,79														
			1 1/2 x 63	461061112	13,46																		
	S-69		1 1/4"	461069114	7,03		1 1/2"	461030112	17,80														
			1 1/2"	461069112	7,31																		
	S-84		1 1/4 x 63	461084114	12,76	S-501 LAVABO / BIDET  <table border="1"> <tr> <td>1 1/4 x 63</td> <td>461050114</td> <td>8,77</td> </tr> <tr> <td>1 1/2 x 63</td> <td>461050113</td> <td>8,98</td> </tr> </table>				1 1/4 x 63	461050114	8,77	1 1/2 x 63	461050113	8,98								
	1 1/4 x 63	461050114	8,77																				
1 1/2 x 63	461050113	8,98																					
		1 1/2 x 63	461084112	13,46	CLICK-CLACK FLAT LAVABO / BIDET S-600 (C)  <table border="1"> <tr> <td>1 1/4 x 63</td> <td>461054010</td> <td>13,13</td> </tr> <tr> <td>1 1/2 x 63</td> <td>461054011</td> <td>14,47</td> </tr> </table> S-601 (N)  <table border="1"> <tr> <td>CROMO</td> <td>991393080</td> <td>21,58</td> </tr> <tr> <td>VALVULA CLIC-CLAC</td> <td>Con Rebosadero</td> <td></td> </tr> <tr> <td>NEGRO</td> <td>460000413</td> <td>25,07</td> </tr> </table>				1 1/4 x 63	461054010	13,13	1 1/2 x 63	461054011	14,47	CROMO	991393080	21,58	VALVULA CLIC-CLAC	Con Rebosadero		NEGRO	460000413	25,07
1 1/4 x 63	461054010	13,13																					
1 1/2 x 63	461054011	14,47																					
CROMO	991393080	21,58																					
VALVULA CLIC-CLAC	Con Rebosadero																						
NEGRO	460000413	25,07																					
	S-151		1 1/4"	461015114	6,10		1 1/2 x 70	461051112	18,62														
			1 1/2"	461015112	6,56																		
	S-29		1 1/4"	461029114	7,39	 <table border="1"> <tr> <td>1 1/2 x 85</td> <td>461017412</td> <td>9,36</td> </tr> <tr> <td>1 1/2 x 70</td> <td>461015812</td> <td>6,89</td> </tr> </table>				1 1/2 x 85	461017412	9,36	1 1/2 x 70	461015812	6,89								
	1 1/2 x 85	461017412	9,36																				
1 1/2 x 70	461015812	6,89																					
		1 1/2"	461029112	7,62																			
	S-39		1 1/4"	461039114	7,39		(1)	461033700	28,53														
			1 1/2"	461039112	7,62		(2)	461023700	28,96														
	S-380		1 1/2"	461038000	32,36	1 1/2 x 115 (1) S-337 (2) S-237 S-236 Rebosadero rectangular		461023600	22,39														
			SOLFLESS	991360285	10,32																		
	KELSO (Valv. Autom.)		1 1/2 x 40	991302010	27,87																		
						S-34 1 1/2 x 40 461034112 21,64																	

FONTANERÍA

JIMTEN

MEDIDA			REF.	€	MEDIDA			REF.	€
 <p>S-578</p>	1 1/2 x 90	461013578	38,18	  <p>40/50</p> <p>460415050</p> <p>10,44</p> <p>40/50</p> <p>461132278</p> <p>13,83</p>		  <p>50/40</p> <p>460419250</p> <p>8,89</p> <p>50/40</p> <p>460419150</p> <p>8,89</p>		<p>SUMIDEROS</p>  <p>75</p> <p>460424775</p> <p>23,12</p> <p>90</p> <p>460424790</p> <p>37,16</p> <p>110</p> <p>460424711</p> <p>37,13</p>	
	1 1/2 x 85	461013678	28,66						
	1 1/2 x 80	461013480	7,79						
 <p>S-134</p>	1 1/2 x 115	461013415	10,32	 <p>CALDERETAS</p>  <p>110</p> <p>460424811</p> <p>41,08</p>		 <p>S-258</p> <p>110</p> <p>460424820</p> <p>37,35</p>			
 <p>SOLFLESS</p> <p>90/110</p> <p>991310903</p> <p>18,24</p>				 <p>CICLÓN 3</p> <p>461117551</p> <p>899,96</p> <p>5M ↑</p>	 <p>ESTACIÓN DE BOMBEO</p> <p>461117541</p> <p>714,05</p> <p>7M ↑</p>		 <p>T. FRANCIA</p> <p>991305041</p> <p>9,40</p>  <p>BLANCO</p> <p>991305042</p> <p>9,37</p> <p>BLANCO</p> <p>VÁLVULA CESTA</p>		
 <p>SOLFLESS</p> <p>32x1"1/4</p> <p>991360258</p> <p>15,84</p> <p>DURBAN</p>				 <p>32x1"1/4</p> <p>991360257</p> <p>14,94</p> <p>KROM</p>	 <p>BLANCO</p> <p>TIERRA FRANCIA</p> <p>991305061</p> <p>11,41</p> <p>BLANCO</p> <p>991305062</p> <p>11,38</p> <p>T. FRANCIA</p> <p>VÁLVULA CESTA</p> <p>CON REBOSADERO</p>				
 <p>32x1"1/4</p> <p>991360259</p> <p>19,07</p> <p>LOIRA</p>									

JIMTEN

		MEDIDA	REF.	€			MEDIDA	REF.	€	
	S-182 CROMO	1 1/4"	460618214	30,99		S-183 CROMO	1 1/4 x 1 1/2 - 40/50	991360248	3,25	
		1 1/2"	460618212	32,46			A-104	1 1/4 x 32/40	461010432	7,74
								1 1/2 x 40/50	461010140	8,64
	S-205 CROMO	1" 1/4	460618314	32,09		PANTHER	1 1/4 x 32/40	991360246	4,46	
		1" 1/2	460618312	32,49			1 1/2 x 32/40	991360247	4,48	
		11/4"x70	460620524	47,95			S-16	8-15	461316008	0,48
11/2"x70	460620522	47,95	12-25	461316015	0,48					
	A-35 CROMO	32-1 1/4"	460635114	13,78		S-130	32-35	461316032	0,48	
		40-1 1/2"	460635112	3,00			40-45	461316040	0,64	
		40-1 1/2"	460000414	9,36			90	460213090	11,90	
	A-68 CROMO	32	460668114	8,60		A-15	1 1/4"	461315114	2,54	
		40	460668112	9,03			1 1/2"	461315112	2,76	
		32	460000402	3,04			A-14	1 1/4"	461314114	4,23
40	460000406	3,07	1 1/2"	461314112	4,90					
	IBIDE	32-1 1/4"	461311432	0,60		TAPÓN A-126	1/2" Azul	461012613	1,32	
		40-1 1/2"	461311240	0,60			1/2" Rojo	461012612	1,32	
		32-1 1/2"	461311232	0,60						
	A-137 CROMO	32	460613714	9,45		A-311	1 1/2"	461340112	2,72	
		40	460613712	8,35						
		40	460000416	4,29						
	A-72 CROMO	1" 1/4	460672114	7,84		A-1	1 1/2"	461301112	9,03	
		1" 1/2	460672112	8,31						
		1" 1/2	460000415	3,92						
	A-7	1" 1/4	461307114	2,93		A-319	1 1/2"	461350112	8,85	
		1" 1/2	461307112	2,93						
		32-40 x 1" 1/4	460613114	24,53						
	A-131 CROMO	40-50 x 1" 1/2	460613112	25,60		A-2	1 1/4"	461302114	4,27	
							1 1/2"	461302112	2,50	
	ALARGADERA CROMO 40 x 50mm		460000530	7,55		A-22		461322112	2,48	
							1"1/4x32	461303114	2,49	
							1"1/4x40	461304114	2,76	
	ALARGADERA SIFÓN LATÓN CROMADO		460000044	6,88		A-3	1"1/2x40	461303112	4,17	
							40mm (Jimten)	461304940	4,90	
							40mm (Adequa)	461100544	1,57	
					A-49	32mm (Adequa)	461100543	1,28		



EL ÚNICO SISTEMA
PP-R y PE-100
FABRICADO EN ESPAÑA

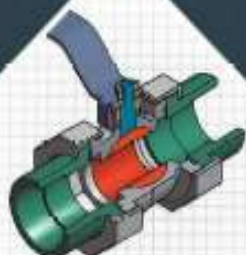

REPOLEN[®]



PPR SYSTEM



PE-100 SYSTEM



PE-RT II SYSTEM



HERRAMIENTAS Y ACCESORIOS



BATERÍAS Y COLECTORES



TUBOS P.E. Y ACCESORIOS



ACCESORIOS COMPRESIÓN

Zona Norte: Jose Requena
jose.ventas@reboca.com
+34 654 192 867

Zona centro: Sergio Ortega
sergio.ventas@reboca.com
+34 671 342 061

Zona Sur: Francisco Ubelda
francisco.ventas@reboca.com
+34 656 094 610

BATERIAS DE CONTADOR

	MEDIDA	REF.	€		MEDIDA	REF.	€
 CENTRAL *Precios sin llaves	2 1/2" - 2" 3/4" 6	601062346	279,66	 REVERSIBLE * Precios sin llaves	2 1/2" - 2" 3/4" 4	601082344	228,63
	2 1/2" - 2" 3/4" 8	601062348	293,39		2 1/2" - 2" 3/4" 6	601082346	306,61
	2 1/2" - 2" 3/4" 10	601073410	337,00		2 1/2" - 2" 3/4" 8	601082348	350,22
	2 1/2" - 2" 3/4" 12	601073412	358,15		2 1/2"- 2" 3/4" 10	601082350	391,19
	2 1/2" 3/4" 14	601073414	396,48		2 1/2"- 2" 3/4" 12	6123412	326,00
	2 1/2" 3/4" 16	601073416	437,44		2 1/2" 3/4" 14	612123414	355,00
	2 1/2" 3/4" 18	601073418	471,81		Juego Llaves 3/4	601099999	17,32
	2 1/2" 3/4" 20	601073420	500,88				
	2 1/2" 3/4" 22	601073422	543,17				
	2 1/2" 3/4" 24	601073424	557,71				
	2 1/2" 3/4" 26	601073426	596,04				
	2 1/2" 3/4" 28	601073428	634,36				
	Juego Llaves 3/4	601099999	17,32				
 VALVULA C/RETENCION 3/4 BOSTON	102035222	19,40		 VALVULA ESFERA BRIDA 3/4	601088134	21,22	



BATERIA ACERO GALVANIZADO
2 FILAS

Nº CONTADORES	FILAS	PULGADAS	REF.	EUROS
12	2	2 1/2"	20122S	348,56
14	2	2 1/2"	20142S	375,55
16	2	2 1/2"	20162S	402,29
18	2	2 1/2"	20182S	432,67
20	2	2 1/2"	20202S	455,17
22	2	2 1/2"	20222S	480,63
24	2	2 1/2"	20242S	506,92



BATERIA ACERO GALVANIZADO
2 FILAS

Nº CONTADORES	FILAS	PULGADAS	REF.	EUROS
12	3	2 1/2"	30123S	403,57
15	3	2 1/2"	30153S	445,59
18	3	2 1/2"	30183S	486,99
21	3	2 1/2"	30213S	528,12
24	3	2 1/2"	30243S	568,13



VÁLVULA ESFERA
ENTRADA
21,8 IZQUIERDA

100101300 36,78



SIL TUERCA 3/4 H
SAL.IZQ.

100102100 2,54



VÁLVULA ESFERA
SALIDA
21,8 IZQUIERDA x 3/4

100101301 26,70

BATERIAS DE CONTADOR

	MEDIDA	REF.	€
DEPÓSITO HIDRONEUMÁSTICO GRUPOS DE PRESIÓN			
	Sin patas (10 bar-1")		
	24 lts.	141805061	49,73
	Con patas (10 bar-1")		
	50 lts.	141804021	120,32
	80 lts.	141804025	151,69
	100 lts.	141804063	220,96
	Con patas (10 bar-1" 1/4)		
	150 lts.	141804022	348,44
	200 lts.	141804023	390,64
	300 lts.	141804024	469,52
CALDERIN SIN MANTENIMIENTO			
	24 lts.	141855024	88,00
	60 lts.	141855060	266,70
	100 lts.	141855061	431,00
	150 lts.	141855062	611,35
	CHORRO ÚNICO AGUA FRIA 3/4		
	991393089	42,09	
CHORRO MULTIPLE 1" (DN20)			
	6029 06	86,78	
DIDO PLATA *Cumple CTE			
	1" 1/4	600420146	470,00
	1" 1/2	600420148	590,00
	2"	600420147	640,00

	MEDIDA	REF.	€
REDUCTOR DE PRESIÓN			
	1/2	991375020	27,40
	3/4	991375022	30,56
	1	991375023	49,97
	1 1/4	991375007	78,40
	1 1/2	991375008	97,66
	2	991375009	113,10
Honeywell			
	1/2	180620004	123,80
	3/4	180620005	128,70
	1	180620006	169,00
D06			
	Manometro glicerina 63 (0-10) 1/4		140263006 14,22
		Termómetro dorsal 0-120 con vaina	
		Termómetro contacto 63 con muelle	
		Manómetro toma posterior	
		Manómetro seco	

BOMBAS

REF.			€	REF.			€
Viviendas tipo D	Alturas edificio	Caudal max. M3/h		Altura (m.c.a)	Modelo		
De 1 a 10	Hasta 12	2,4 - 9,6		80-27	AP-HI MASTER A/15-2	4.497,00	
De 11 a 20	Hasta 8	2,4 - 9,6		80-27	AP-HI MASTER A/15-2	4.497,00	
De 21 a 30	Hasta 14	4,8 - 14,4		96-41	AP-HI MASTER B/25-2	4.695,00	
De 31 a 50	Hasta 6	4,8 - 14,4		96-41	AP-HI MASTER B/25-2	4.695,00	
				1 bomba <i>sin alternancia</i> AP HI B-15		1.801,88	
				1 bomba <i>sin alternancia</i> AP HI B-20		1.932,42	
	0,75 CV	140291037	467,00		141203254	70,71	
GP-AGA				CONTROL PRESS 1,5 / 3 BAR			
		140262277	104,00		141203253	70,71	
PRESOSTATO ELECT. SWITCH MATIC 2				BOYA AGUAS LIMIAS			
	0,8 CV	140251057	413,00		5 MTS		
	1 CV	140251067	530,00		141050004	29,00	
	1,2 CV	140251097	643,00				
GP-COMPACT				BOYA AGUAS FECALES			
				10 MTS			
				140262201			
				108,00			

BOMBAS

AGUAS SUCIAS			AGUAS LIMPIAS		
	REF.	€		REF.	€
 <p>RIGTH 75MA</p> <p>*0,75 CV *Paso solidos 35mm</p>	140217531	609,00	 <p>OPTIMA MA</p> <p>*0,33 CV Paso sólidos 10mm</p>	140217511	358,00
 <p>DAR</p> <p>*1,5 CV *Paso solidos 50mm</p>	140261012	923,00	 <p>OPTIMA MS</p> <p>*0,33 CV Paso sólidos 10mm</p>	140217521	388,00
 <p>VERSATYLE (SG1000)</p>	140261011	516,00	 <p>BESTONE VOX (VORTEX)</p> <p>*0,33 CV Paso sólidos 20mm</p>	140217411	446,00
 <p>13.000 L/H</p>	420402293	77,45	 <p>LAGO</p> <p>300</p>	140292011	206,00
 <p>15.500 L/H</p>	420402295	112,45	 <p>500</p>	140292021	231,00
			 <p>6.000 L/H</p>	420402288	59,45



E.SYBOX MINI

140463600	1.073,00
-----------	----------



RACORES 1"

140400630	46,00
-----------	-------





E.SYBOX

140447200	1.796,00
-----------	----------

BOMBAS (AGUAS LIMPIAS)

REF.	€	REF.	€
	QDP-400A 140102001	HMC90-3SH 140101001	170,79
	76,17		
	*0,55 CV		*0,9 CV

BOMBAS (AGUAS SUCIAS)

REF.	€	REF.	€
	H800F-B 140103002		HWD-750S 140103003
	172,76		251,34
	QDS-750CW 140103001		
	123,97		

MODELO	H800F-B	QDS-750CW	HWD-750S
POT. (Cv)	1,1 Cv	1 Cv	1 Cv
H MAXIMO (m)	10 m	9 m	12 m
Q MAXIMO (m ³ /h)	18 m ³ /h	9,6 m ³ /h	15 m ³ /h
CONEXIÓN	2"	1 1/2"	1 1/2"

BOMBAS (CONTROL)

REF.	€	REF.	€
	EPC-1 140104001		EPC-3 140104002
	38,52		37,21

HERRAMIENTAS

MEDIDA REF. €			MEDIDA REF. €		
	420400722	17,45		7"	420407522 18,95
COTATUBOS MINI 722				10"	420400522 23,45
	420400725	20,45		12"	420412522 31,05
CORTATUBOS 725				L=10"	420401399 56,95
	CU 35 420400735 48,95			L=14"	420401400 61,45
	INOX 42 420400238 56,45			L=18"	420401301 84,45
CORTATUBOS TELESCOPICO 735				L=24"	420401302 148,95
	420400750 129,95			1/2"	420400500 46,45
	PE 6-67mm 420470031 134,95			1"	420401000 54,45
	PE 50-125mm 420470032 232,45			1 1/2"	420401501 75,45
CORTATUBOS AUTOMATICO 750				2"	420402000 116,45
	420461004	299,95			420403506 20,95
BOMBA DE COMPROBACION RP 50 S					420403508 16,95
	420400902	14,45			420403510 18,45
GRIFOS PARA BOTELLA AZUL					420403512 29,95
					420403515 49,45
					420400170 14,95
					420401202 2,55
					420401203 1,15
					420485112 815,95
					BOMBA DESINCRUSTANTE ROCAL 20
					10 Kg. (cu) 420400851 67,95
					5 Kg. (cu) 420400850 38,45
					420400852 23,45
					LIQUIDOS DESINCRUSTANTES
					NEUTRALIZANTE

HERRAMIENTAS

MEDIDA			REF.	€	MEDIDA			REF.	€
	7,5 m	ROSPI	420419950	164,95		2 m.	420400002	17,45	
	MUELLE 8mm x 7,5 mts.		420472412	96,45		5 m.	420400005	25,45	
	10 mts	ROSPI	420417205	255,45	METRO 5 m.				
	MUELLE 10mm x 10 mts.		420402422	123,95					
	Conex. EU		420405501	115,45	BOMBA DE VACÍO R32				
	+ Botella								
	PACK 10 DISCOS 115.1,5 (1 UD.)		420485510	21,95	420401510				
	DISCO METAL 1,5		420610015	2,28	214,45				
	26 TC		420405090	38,95					
	32 TC		420405085	54,95	7,15				
	Cuchilla		420452041	28,45					
	42 TC		420405091	70,95	RO MAPP				
	Cuchilla		420405092	41,45	18,45				
	50 TC		420405093	100,95	ABOCINADOR R32				
					59,45				
	63 TC		420405094	146,95	MANÓMETRO R32				
					48,95				
	75 TC		420405095	244,95	MANGUERAS R32				
					39,95				
					LLAVES ALLEN EN SOPORTE METALICO				
					2,5 - 10 mm.				
					8,25				
					3/8" - 3/4"				
					68,95				
					LLAVE DE RADIADORES				
					420403105				
					40,95				
					ALFOMBRA IGNÍFUGA				

HERRAMIENTAS

REF.	€	REF.	€
 <p>SOPLETE KT777P</p> <p>423010121 91,78</p>	<p>(3) </p> <p>(4) </p> <p>(3) BOTELLA DE GAS KSUPRAGAS330</p> <p>423010102 4,40</p> <p>(4) BOTELLA DE GAS MAP-PLUS</p> <p>423010101 7,70</p>		
 <p>SOPLETE KT637</p> <p>423010127 61,62</p>	 <p>42mm 423010123 29,57</p> <p>50mm 423010113 42,03</p> <p>TIJERA</p>		
 <p>SOPLETE KT637</p> <p>423010103 40,40</p>	 <p>CORTATUBOS 6-35</p> <p>423010162 12,92</p>		
 <p>SOPLETEKT937</p> <p>423010128 32,04</p>	 <p>TIJERA</p> <p>35MM 423010122 8,10</p>		
 <p>SOPLETE KT957RTN</p> <p>423010129 37,70</p>	 <p>BOMBA DE COMPROBACIÓN MANUAL KHTP-50</p> <p>423010107 183,95</p>		

HERRAMIENTAS

		REF.	€			MEDIDA	REF.	€
 SPORT TALLAS 40-46	40	423010142	31,85	 RACING TALLAS 40-46	40	423010152	31,01	
	41	423010143	31,85		41	423010153	31,01	
	42	423010144	31,85		42	423010154	31,01	
	43	423010145	31,85		43	423010155	31,01	
	44	423010150	31,85		44	423010147	31,01	
	45	423010151	31,85		45	423010148	31,01	
46	423010146	31,85	46	423010149	31,01			
 SQUASH TALLAS 41-46	41	423010156	34,37	 RODILLERAS GEL	423010139	21,24		
	42	423010157	34,37					
	43	423010158	34,37					
	44	423010159	34,37					
	45	423010160	34,37					
	46	423010161	34,37					
 POLIFUSOR KPHPW800W Ø 20-63	423010105	93,10						
	 POLIFUSOR KPHPW1200W Ø 75-90-110	423010106	106,42					
 GUANTE FLEX PRO KAP442 1,2mm		T-7	423046360	3,19	 GUANTE FLEX KAP440 1mm	T-7	423046364	2,19
	T-8	423046361	3,19	T-8		423046365	2,19	
	T-9	423046362	3,19	T-9		423046366	2,19	
	T-10	423046363	3,19	T-10		423046367	2,19	
 LLAVE DE CADENA REVERSIBLE 4"	423010124	28,54						
	 LLAVE DE CORRE 12"	423010125	28,55					
 TIJERA CHAPA PLADUR		423010140	16,04					
	 SERRUCHO PLADUR	423010141	12,45					
 MUELLE DESATASCADOR		8mm x 5mts	423010137	13,41				
	ALUMINIO	6mm x 3mts	423010108	7,30				
14"		423010134	35,19					
18"		423010135	44,01					
 TENAZA CANAL 10"	24"	423010136	52,77					
	423010109	10,42						
 GRAN APERTURA	6"	423010131	15,34					
	8"	423010132	17,64					

RP 115 HERRAMIENTA DE PRENSAR

RIDGID

¡NOVEDAD!

RIDGID PRESENTA LA NUEVA **RP 115**

MICRO | **RENDIMIENTO**
PRENSADO | **SOBRESALIENTE**



MICRO para facilitar el uso en pequeños espacios



La más ligera del mundo, con un peso de tan solo 1,38 Kg*



Gran Potencia y fiabilidad para pequeños diámetros:
Cu / ST - max. 28 mm
Pex / MPL - max. 32 mm



Ciclo de prensado en 3 Seg.



Cabezal de rotación de 350°
Prensa en cualquier sitio y en cualquier posición.



Diseño ergonómico SlimGrip™
Perfecto manejo y control







Mordazas MICRO de 15Kn
para mejor acceso de prensado



DOS baterías, con comprobador de carga incluido.

HERRAMIENTAS

MEDIDA	REF.	€	MEDIDA	REF.	€	
	423057043	94,72	MAQUINA PRENSAR RP115 (16-32) INCLUYE 2 BATERIAS			
MUELLE	423042163	46,73		PACK 16-20-25	423073898	1.199,00
DESATASCADORA POWER SPIN+				INOX M15	423069357	134,50
				INOX M18	423069359	134,50
				INOX M22	423069360	134,50
	423076188	495,65	INOX M28	423069361	134,50	
EQUIPO DE LIMPIEZA DE TUBERIAS K9			INSERCION RFz 32	423069358	88,18	
	423059143	341,40	DESATASCADORA K-45 Hasta 75mm			
DESATASCADORA POWERCLEAR™				423036043	582,00	
CABLE REPUESTO	423055983	66,10	MUELLE	423056782	145,70	

BROCAS



MEDIDA MM	CODIGO	REF.	€	MEDIDA MM	CODIGO	REF.	€	
TWISTER PLUS SDS	6 x 110	423076110	110D06L0110	3,49	MULTIMATERIAL	6	215D06	5,07
	6 x 160	423076160	110D06L0160	3,49		8	215D08	5,59
	8 x 160	423078160	110D08L0160	3,88		10	215D10	6,28
	10 x 160	423070160	110D10L0160	5,00		12	215D12	7,76
OPTIMA 3+ HORMIGÓN	5	423072635	263D05	2,62	BLUE CREAM	6	423042606	23,72
	6	423072636	263D06	2,69		8	423042608	25,55
	8	423072638	263D08	3,18	ADAPTADOR PARA AMOLADORA	Ø 1'5 - 13	423001240	62,55
	10	423072630	263D10	4,45				
BROCA VIDRIO	4	423074004	400D04	5,29	4G4 SDS	6 x 160	423071121	4,95
	5	423074005	400D05	5,73		6 x 210	423071122	5,31
	6	423074006	400D06	6,13		8 x 160	423071123	5,73
	8	423074008	400D08	6,98		8 x 210	423071124	6,11
						10 x 160	423071125	6,27
						10 x 210	423071126	6,98
						12 x 160	423071127	6,78



Almacén de Fontanería

**PISCINAS - FOSAS Y DEPURADORAS -
TRATAMIENTOS DE AGUA - AEROTERMIA -
CALEFACCIÓN - GRIFERÍAS - MATERIAL
CONTRAINCENDIOS - GAS -
DESCALCIFICADORES - SANITARIOS -
ACCESORIOS PARA BAÑOS PÚBLICOS -
BOMBAS DE AGUA - VALVULERÍA -
TUBERIAS - VENTILACIÓN - DEPÓSITOS -
MÁQUINAS - HERRAMIENTAS - TERMOS -
ACUMULADORES - AIRE ACONDICIONADO**

Siempre Cerca de tí

ALMACÉN

C/ JUAN RAMÓN JIMÉNEZ, 11-13
46930 QUART DE POBLET
TEL. 961548962

quart@suministroscoplasa.com

**ALMACÉN - OFICINAS
SHOWROOM**

C/ DOMINGO GÓMEZ, 23
46025 VALENCIA
TEL. OFICINAS: 963471573
TEL. ALMACÉN: 963473527

valencia@suministroscoplasa.com

www.suministroscoplasa.com



ALMACÉN

C/ TANDA XICA, 29 - NAVE 2
P.I. CAMÍ DE LA VILA
46800 XÁTIVA
TEL. 961712387

xativa@suministroscoplasa.com

**14ª Feria del
Instalador**